

NEW U-S-W FREQUENCY CHANGER

The **Wireless**  
**World**

MONTHLY  
ONE SHILLING

*COVERING  
EVERY WIRELESS INTEREST*

MAY, 1941



KEEPING IN TOUCH WITH OUR BOMBERS

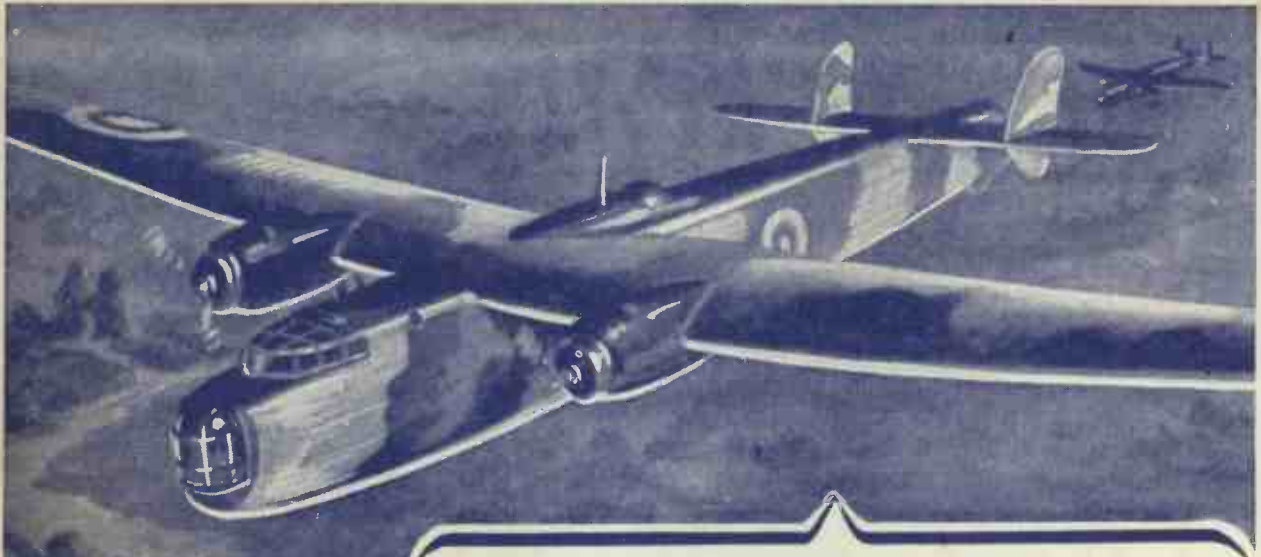

# SILVERED MICA CONDENSERS

for **SERVICE** and the **SERVICES**

U.I.C. Condensers are on duty everywhere to-day because experience has shown their worth. Incessant progress in methods and research linked with the most thorough mechanical and electrical inspection are the reasons why.

**EVERY U.I.C. CONDENSER IS TESTED BY US FOR :**

1. **CAPACITY:** Tolerances can be made as close as  $\pm 0.5\%$ .
2. **LOSS FACTOR:** Average: 0.05% (Maximum: 0.2%) at 1,000 Kc/s.
3. **TEST VOLTAGE:** As specified. Normally 1,000 V. D.C.

Laboratory and production check measurements are made on the effect of repeated cycles of HEAT, HUMIDITY, VOLTAGE (D.C. and A.C.) on CAPACITY, LOSS FACTOR, DIELECTRIC STRENGTH, INSULATION RESISTANCE (in  $10^9$  ohm), NOISE (to a standard of  $2 \times 10^{-6}$  pF/pf/sec.).

Approved as satisfying all current official specifications.

CONTRACTORS TO G.P.O. and GOVERNMENT DEPTS.  
ON A.I.D. APPROVED LIST.

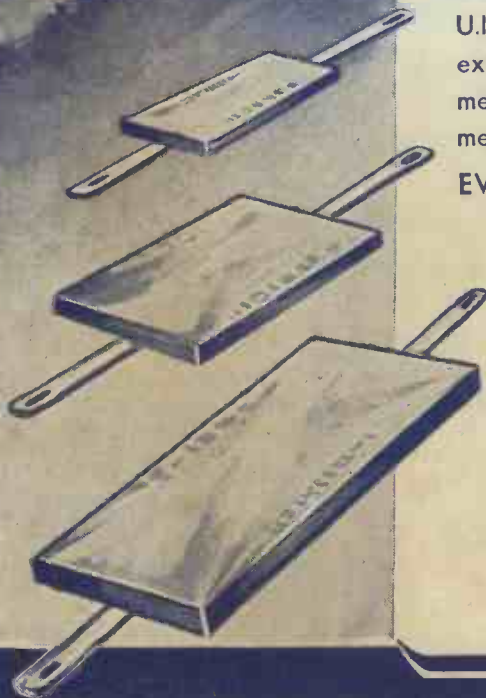

## UNITED INSULATOR CO LTD

*The Pioneers of Low Loss Ceramics*

**12-16 LAYSTALL STREET, LONDON, E.C.1**

Tel: TERMINUS 4118-9

Grams: CALANEL, SMITH, LONDON



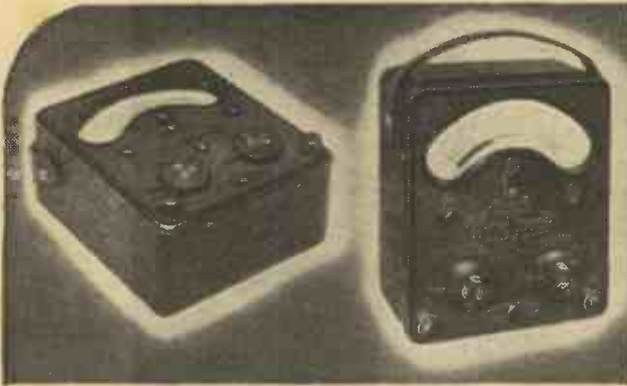

46-range Model 7  
Universal AvoMeter

40-range Model 40  
Universal AvoMeter



"Avo" Valve Tester with Universal Panel

# PRECISION METERS

*that Master every Testing Problem*

The world-wide use of "AVO" Instruments is striking testimony to their outstanding versatility, precision and reliability. In every sphere of electrical test work—laboratory, shop or out on a job—they are appreciated for their dependable accuracy, which is often used as a standard by which other instruments are judged. There is an "AVO" Instrument for every essential electrical test.

In spite of greatly increased production, most of our output of "AVO" Instruments is being taken by the Services Delay in delivery of Trade Orders is consequently inevitable but we shall continue to do our best to fulfil your requirements as promptly as possible.



## ELECTRICAL MEASURING INSTRUMENTS

BRITISH MADE

● Write for fully descriptive literature dealing with any instrument in which you are interested, and for current prices.

Sole Proprietors and Manufacturers:—

**THE AUTOMATIC COIL WINDER & ELECTRICAL EQUIPMENT Co., Ltd.,** Winder House, Douglas St., London, S.W.1

Phone: Victoria 3404-7.

All-Wave "Avo" Oscillator

"Avo" Test Bridge

Universal AvoMinor

D.C. AvoMinor



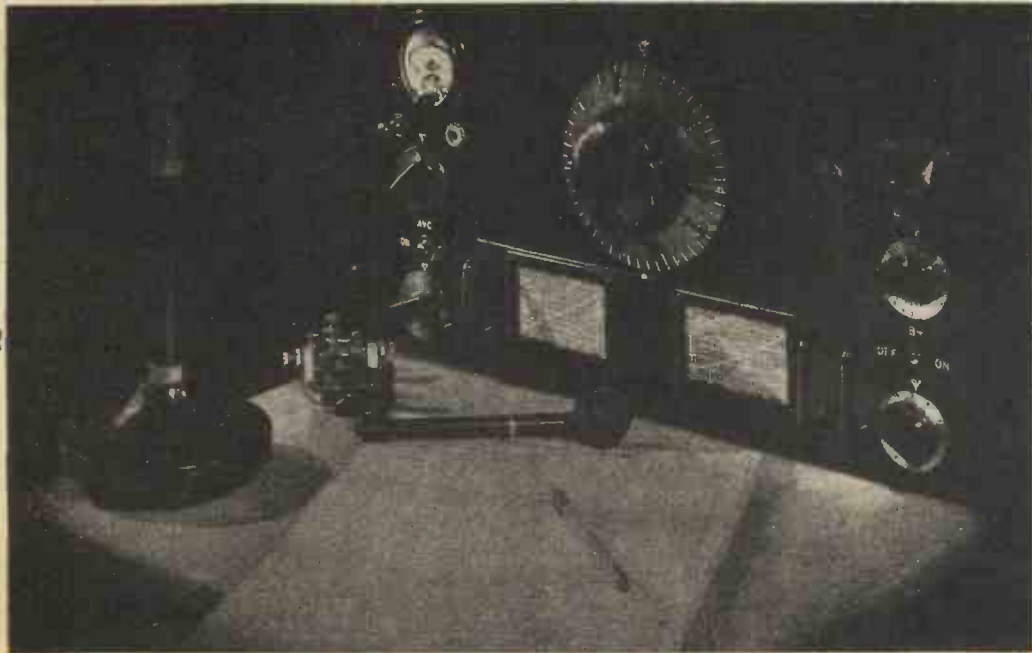

THE NATIONAL HRO IS ACKNOWLEDGED AS THE MASTER OF DIFFICULT OPERATING CONDITIONS. OVER THE PAST FIVE YEARS ITS HIGH PERFORMANCE IN THE HANDS OF ACKNOWLEDGED EXPERTS, AND THE FACT THAT IT IS ALMOST EXCLUSIVELY USED BY THE SERVICES, IS A WONDERFUL TRIBUTE WHICH ENTITLES US TO BE PROUD TO ACT AS NATIONAL HRO DISTRIBUTORS IN THE BRITISH ISLES. SUPPLIES AT THE MOMENT ARE ONLY AVAILABLE FOR GOVERNMENT USE AND FOR THOSE ON WORK OF NATIONAL IMPORTANCE.

## Raymart Insulators and Ceramic Goods

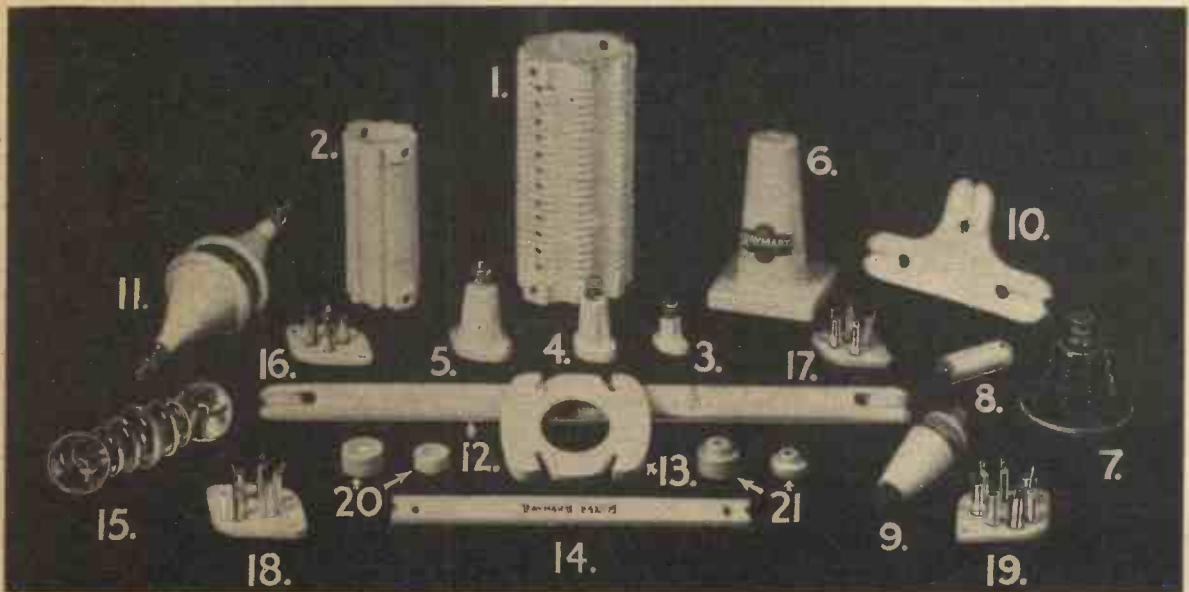

OUR ILLUSTRATION GIVES BUT A SMALL INDICATION OF THE WIDE VARIETY OF INSULATORS AND CERAMIC GOODS AVAILABLE FROM RAYMART, WHO CARRY THE LARGEST RANGE OF THESE PRODUCTS IN THE COUNTRY. THERE ARE MANY OTHER RAYMART LINES APPROVED AND USED BY H.M. SERVICES. MICRO-VARIABLE CONDENSERS—PRECISION DIALS AND A LARGE SELECTION OF SPECIALITIES FOR SHORT-WAVE WORK.

# RADIOMART

G5NI (BHAM) LTD.

DIRECTORS: W. M. D. NIGHTINGALE L. NIGHTINGALE  
44 & 48 HOLLOWAY HEAD, BIRMINGHAM, 1  
Cables: Raymart, Birmingham. Telephone: Midland 3254

All orders and enquiries relating to the above products should be sent to Radiomart G5NI (Birmingham) Ltd., the official distributors for National HRO and all Raymart lines. When writing please mention "as advertised in The Wireless World."



# INSIDE INFORMATION

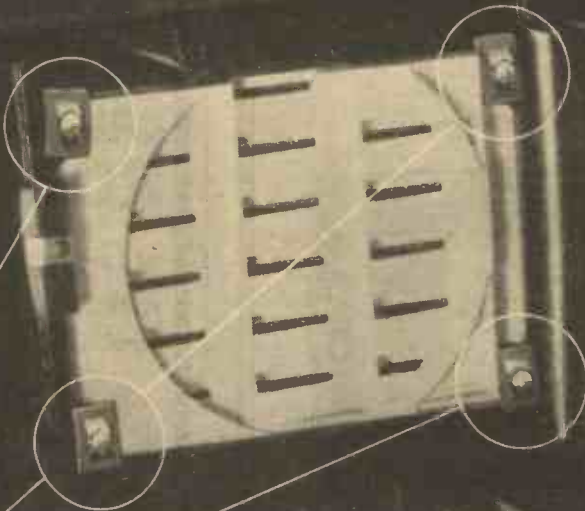

Above is shown one of the standard Speed Nuts used by Ultra Electric Ltd., in their latest receivers. It can be speedily zipped into position and replaces the conventional type of plain washer, lock washer and nut.

## Radio assembly speeded up and costs reduced with



Speed Nuts replace ordinary nuts and lock washers, and eliminate the complication of threaded inserts in plastic mouldings. The number of parts handled is cut down by half, and considerable savings are effected in both assembly time and material.



Speed Nuts are particularly adaptable to all types of knob-to-shaft assemblies, and invaluable for 'blind' locations, whilst porcelain and glass can be securely held without damage. Speed Nuts are proof against vibration.

★ Our Development Department will be pleased to collaborate and submit suitable designs to meet your particular needs.

 **SIMMONDS AEROCESSORIES LTD**   
GREAT WEST ROAD, LONDON.

**Now Available!!**  
NEW **74** RANGE  
UNIVERSAL TAYLORMETERS



Model 81A. Sensitivity 4,000 ohms per volt on A.C. and D.C.  
Model 81C. Sensitivity 20,000 ohms per volt on BOTH A.C. and D.C.

**TAYLOR MODELS 81A and 81C**

IMPORTANT FEATURES TO NOTE:

**METER**

4 1/4" square type Taylor moving coil meter.

**SCALES**

There are 6 scales, the outer being 3 1/2" long.

**RANGES**

\*D.C. VOLTS. 0-0.1, 0-0.2, 0-2.5, 0-5, 0-10, 0-20, 0-25, 0-50, 0-250, 0-100, 0-200, 0-250, 0-500, 0-1,000, 0-2,000.

\*A.C. VOLTS. 0-2.5, 0-5, 0-10, 0-20, 0-25, 0-50, 0-100, 0-200, 0-500, 0-1,000, 0-2,000.

\*OUTPUT. 0-2.5, 0-5, 0-10, 0-20, 0-25, 0-50, 0-100, 0-200, 0-250, 0-500, 0-1,000, 0-2,000.

D.C. CURRENT (Model 81A), 0-250 micro-amp., 0-500 micro-amp. (Model 81C), 0-50 micro-amp., 0-100 micro-amp. (Models 81A and 81C), 0-1 m/a., 0-2 m/a., 0-10 m/a., 0-20 m/a., 0-100 m/a., 0-200 m/a., 0-1 amp., 0-2 amp., 0-10 amp., 0-20 amp.

A.C. CURRENT (Model 81A), 0-250 micro-amp., 0-500 micro-amp. (Model 81C), 0-50 micro-amp., 0-100 micro-amp. (Models 81A and 81C), 0-25 m/a., 0-50 m/a., 0-0.25 amp., 0-0.5 amp., 0-2.5 amp., 0-5 amp.

OHMS (Model 81A), 0-1,000, 0-100,000, 0-10 meg. (0-100 meg. with external battery). (Model 81C), 0-1,000, 0-100,000, 0-50 megohms (with internal battery), 0-1,000 megohms (with external battery).

\*DECIBELS. -22 to +8, -10 to +20, -2 to +28, +10 to +40, +18 to +48, +30 to +60.

\* Applies to both models.

4. Adaptors are available for measuring Capacity and Inductance also for increasing voltage range to 5,000-10,000 A.C. and D.C. and for low resistance measurements.

MODEL 81A - - - £13 - 13 - 0

MODEL 81C - - - £18 - 18 - 0

(No purchase tax payable)

Supplied complete with instruction book and 3 test leads.

Fully descriptive Brochures of both models are available free, on request.

BRITISH MADE • GUARANTEED 6 MONTHS

**TAYLOR**

ELECTRICAL INSTRUMENTS LTD.  
419-422, Montrose Avenue  
Slough, Bucks. Phone: Slough 21381

**B.I. COPPER EARTHING RODS**  
for  
**WIRELESS APPARATUS**



**BRITISH INSULATED CABLES LTD.,**  
CABLE MAKERS AND ELECTRICAL ENGINEERS,  
Head Office: PRESCOT, LANCS.  
Telephone No.: PRESCOT 6571.

**100% MORE SURFACE AREA**

Designed to give a low resistance earth contact. Made from solid drawn H.C. copper. The multiple fins ensure larger surface area and better contact with the earth than any driving earth of similar diameter and weight at present on the market; giving nearly 50 per cent. more contact area than a circular rod of equal diameter, or 100 per cent. more than a solid rod of equal weight. About 1 1/4" of the rod is left exposed and the earth lead is simply clamped against the rod by means of the copper clamp ring and screw. No sweating or soldering is required. Supplied in two standard sizes, 18" and 24". Longer rods of similar type can be supplied, if desired, to meet special requirements.

**M-R SUPPLIES**

offer from stock the following FIRST-CLASS BARGAINS in RADIO and ELECTRO-TECHNICAL EQUIPMENT. Satisfaction assured.

**G.E.C. MODEL 1575 MICROPHONES.** The celebrated Bronze Transverse Cuneiform type (pre-war list £7/10/-), offered, brand new, at 52/6. Also a few MODEL 1574 LAPEL MICROPHONES (about 1 1/4 ins. sq.), complete with cord and connector (pre-war list £4/5/-) 39/6. To-day's finest mike bargains.

**PRELIMINARY AMPLIFIERS** for photo-cell. Readily adapted for microphone. Without valves (require 1 H.F. Pen. and 1 Det.). Require external H.T. and L.T. Fully smoothed and decoupled. Size 3in. by 2 1/2in. by 6 1/2in. high, 15/-.

**PHOTO-ELECTRIC CELLS.** Several large cinema interests took advantage of our last month's announcement. Still a few left of brand new CETRON model 5WB-C, size only 2 1/2in. by 1 1/2in. Suitable for most sub-standard cines and for all light control. Sensitivity 100/400 microamps per lumen. (Similar cells often charged at £5 and over), great opportunity, 29/6. Also last few of the CETRON C.E.I. model, with standard UX cap, 39/6.

**WESTERN ELECTRIC RESISTORS,** 5-watt rating in following values only: -6,500, 8,500, 10,000, 13,050, 15,000, 20,000, 40,000 and 50,000 ohms. Wire wound, shellac protected: 1/- each or 10/6 dozen.

**MERCURY SWITCHES.** Single-pole change over, breaking up to 10-amps. Lead-insulated leads at bottom of tube which is 1 1/2in. long, 4/6.

**ELECTRO-MAGNETIC COUNTERS.** Coil res. 3 ohms or 500 ohms, counting up to 9999. Many domestic and industrial applications, 5/6. Dozen lots 4/10 each.

**PUBLIC ELECTRIC CLOCK MOVEMENTS.** Special heavy duty models fitted with auxiliary motor for remotely starting and re-setting clock. First-class instrument finish. 200/250 v. 50 c. Model A, for clocks up to 4ft. diameter, 49/6. Model B, for clocks up to 6ft. diameter, with set of bushes for hands, 59/6. Suitable c/over switches, 2/6.

**ROTHERMEL-BRUSH D.104 PIEZO-CRYSTAL MICROPHONE INSETS.** As used in the famous 8-guinea D.104 Microphone, only requiring housing. Can be used exactly as supplied. For P.A., deaf-aid, etc., 25/-.

**BRUSH PIEZO-CRYSTAL ELEMENTS.** 2 1/2in. dia., fitted stylus. Very popular: offer for construction of microphone, cardophone, piano-repeater, vibration detector and other domestic and industrial purposes, 6/11.

**GEARED HIGH-TORQUE MOTORS.** Operation 15/30 v. A.C. Final spindle speed 60 r.p.m. Reversible, with auto 2-pole make switch. Made for radio tuning but useful for many other purposes—recording instruments, contact making, drawing cine curtains, etc., 8/6. Also 200/250 v. A.C. model, final speed 3 or 6 r.p.m. (two models) extremely high torque. Synchronous and precision made, 25/-.

**LOW TENSION RECTIFIERS.** Permanent metal type by famous British maker. D.C. delivery, 12/14 v. 1.5 amp., 10/9. Also Heavy Duty Model. D.C. delivery, 12/14 v. 3 to 6 amps., 22/6. (See below.)

**STEP-DOWN MAINS TRANSFORMERS,** to suit above rectifiers and for low voltage shalter lighting, models, etc. All primes, 200/280 v. Sec. 7/11/15 v. 2 amp., 11/6. Sec. 22 v. 2 amp., 13/3 (ideal for Tuning Motors above). Also new Heavy Duty model, for use with 33/6 rectifier, tapped for 6 and 12 v., charging at 5 amps., 35/- (Unbeatable values in high-grade charging equipment).

**BED-SWITCH CONVERSION SETS.** Comprising 2-way conversion tumbler switch (which takes the place of the ordinary 11 switch) 2-way pear switch, 15ft. 3-way silk-covered flex, etc. Very easily installed—instructions sent. (Pre-war list 7/6), 4/11. Or 4/- per set in dozen lots.

**MINIATURE P.M. MOVING COIL UNITS.** Only 3in. dia. For use either mike or speaker and exactly right for all intercom. systems. 12-ohms imp. High-flux alni magnet. Very well made, 13/6. Suitable G.E.C. Transformers, 3/9.

**L.T. SMOOTHING CHOKES.** 4/6. **L.T. SMOOTHING CONDENSERS (T.C.C.)** 1,000 mf. 12 v., 3/8. **B.I. RESIN CORED SOLDER** (50 p.c. tin), 18ft., 2/6.

**ROTHERMEL PIEZO-CRYSTAL PICKUPS,** Standard model, with arm, 37/6. In stock:—ROTARY CONVERTERS, SLIDING RHEOSTATS, ELECTRIC CLOCKS, BATTERY CHARGERS, ELECTRIC MOTORS, etc. Latest list sent with each order.

**M.R. SUPPLIES, 68, New Oxford St., London, W.C.1**  
Telephone: MUSeum 2958



# FREQUENTITE

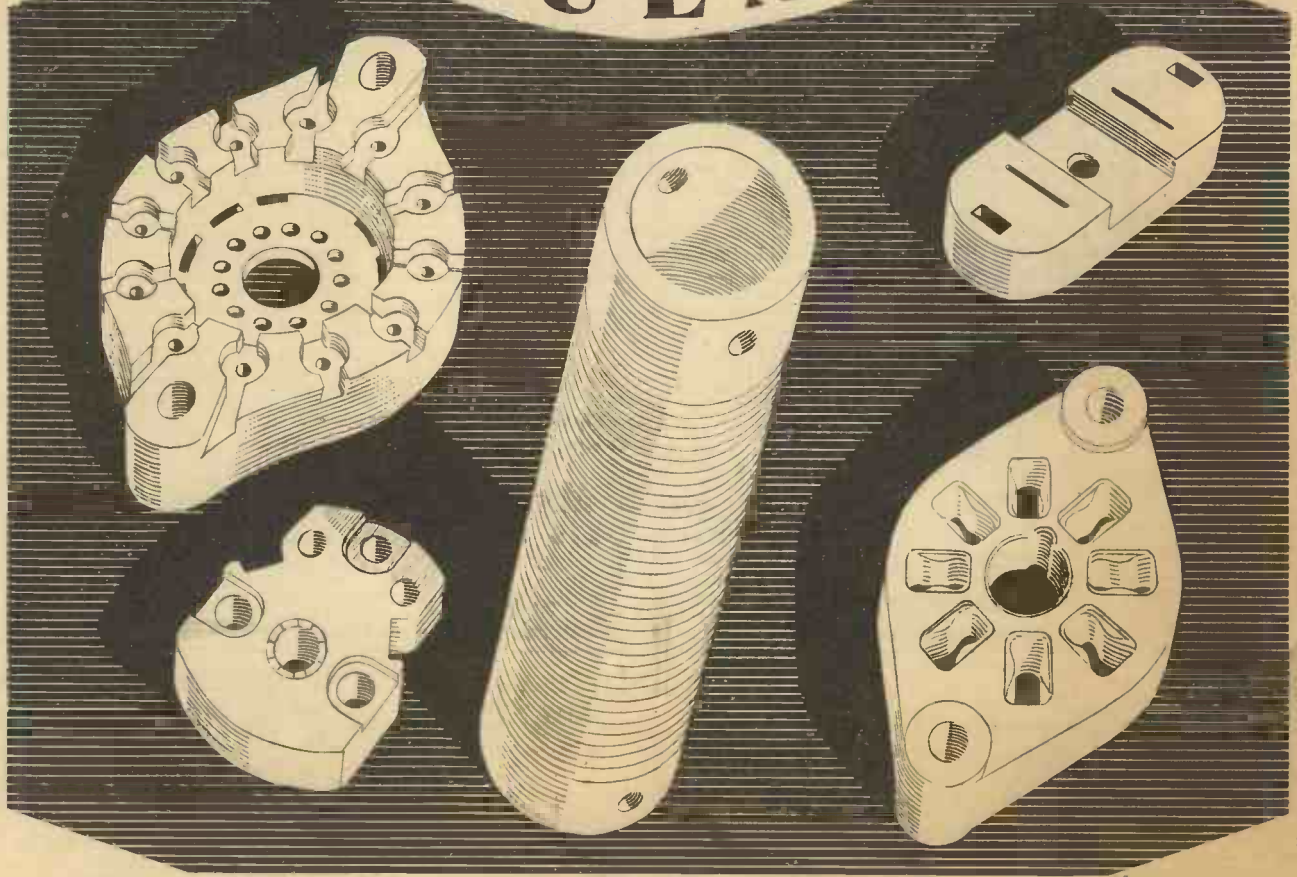

## THE PIONEER BRITISH-MADE LOW LOSS CERAMIC

THE OUTSTANDING properties of Frequentite— Low Loss and High Mechanical Strength—led to a demand which even before the war severely taxed our productive capacity. The needs of the fighting services have inevitably led to restriction in supplies for general industry, *but we can now meet all*

*requirements promptly.* Extensions to our plant, the employment of specialised new equipment, and progressive improvements in our manufacturing technique made during the past seven years, now enable manufacturers to obtain bulk supplies of the most intricate designs. Please write for Catalogue No. SP.10.

## STEATITE & PORCELAIN PRODUCTS LTD.

Head Office and Works :

STOURPORT-ON-SEVERN, WORCS.

Telephone : Stourport 111.

Telegrams : Steatint, Stourport.

SP.4

P. R. MALLORY & CO Inc  
**MALLORY** *Vibrapack* ★

GIVES FLYERS ONE FOOT ON THE GROUND

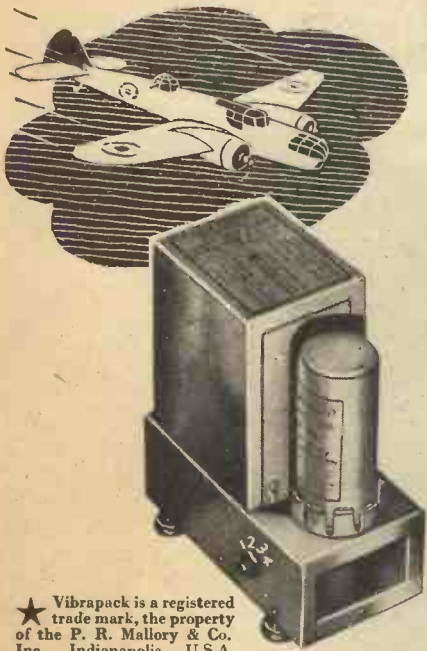

THE widespread popularity of Mollory Vibrapacks for use in aeroplane radio transmitters is additional evidence of the truth of the Mollory slogan "Perfect Portable Power". Pilots know they can rely upon Mollory Vibrapacks for a dependable signal and low battery drain.

Mollory Vibrapacks provide the ideal source of plate voltage wherever commercial electric power is not available, whether it's in the air or on the ground. Vibrapacks are available for operation from both 6 and 12 volt batteries with outputs up to 300 volts at 100 ma. of easily filtered D.C. In addition the low voltage models are ideal for converting 110 volt receivers for 6 volt battery operation.

Radio receiver manufacturers are finding Mollory Vibrapacks ideal for use in their Export model receivers. There are 21 special manufacturers' type vibrapacks available in addition to the following standard types for use in aircraft, boat, police, automobile and similar services.

VP.551 Self-Rectifying	Input 6.3 V.	Output 125-150-175-200 V.
VP.552 " "	" 6.3 V.	" 225-250-275-300 V.
VP.553 Valve " "	" 6.3 V.	" 125-150-175-200 V.
VP.554 " "	" 6.3 V.	" 225-250-275-300 V.
*VP-G.556 Self " "	" 12.6 V.	" 225-250-275-300 V.

\* Especially designed for aircraft, boat and auto service.  
 We can give you prompt service and shipment.

★ Vibrapack is a registered trade mark, the property of the P. R. Mallory & Co. Inc., Indianapolis, U.S.A. Units which do not bear this trade mark are not of genuine Mollory manufacture.

**P. R. MALLORY & CO. INC.**  
 INDIANAPOLIS INDIANA U.S.A

Represented exclusively in Gt. Britain by  
**FRANK HEAVER LTD.**

KINGSLEY RD. · BIDEFORD · N. DEVON · ENGLAND



**MUSIC**

**WHERE YOU WANT IT...**

Have you joined that rapidly increasing number of "listeners" to the new radio pleasure: "Music where you want it"?

Free from the restrictions of one-room radio, they are enjoying their favourite programmes in the shelter, whilst working in the kitchen, or wherever it is convenient to listen; and all by the simple connection of a Stentorian Extension speaker to their existing radio. What's more, these handsome, but moderately priced speakers offer an appreciable improvement in reproduction over most built-in speakers. Why not make full use of your radio NOW by installing a Stentorian? Ask your local dealer for a demonstration.



Cabinet Models for 21/6



**Stentorian**

THE PERFECT EXTRA SPEAKER FOR ANY SET

WHITELEY ELECTRICAL RADIO CO. LTD., MANSFIELD, NOTTS

**WHARFEDALE GOLDEN CHASSIS**

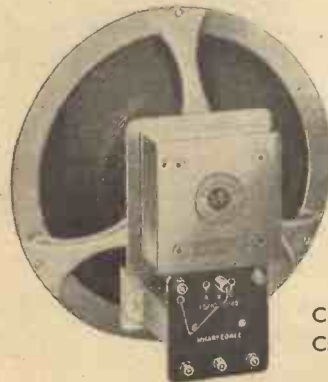

As supplied to the B.B.C.

Supplies of this first-class Loud Speaker are still available.

Delivery 2/3 weeks.

**PRICES:**

	Less Trans.	With Trans.
Chassis only - - -	60/-	75/-
Cabinet Model - - -	97/6	112/6

**RESPONSE CURVE**

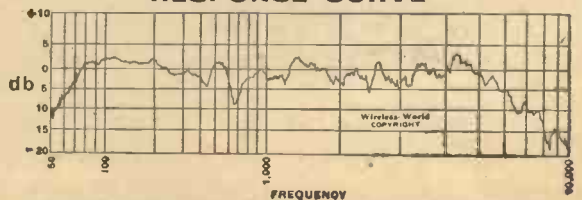

**WHARFEDALE WIRELESS WORKS**  
 SOLE PROPRIETOR: D. E. BRIGGS,  
 HUTCHINSON LANE, BRIGHOUSE, YORKS.  
 'PHONE: BRIGHOUSE-50. 'GRAMS: "WHARFDEL"



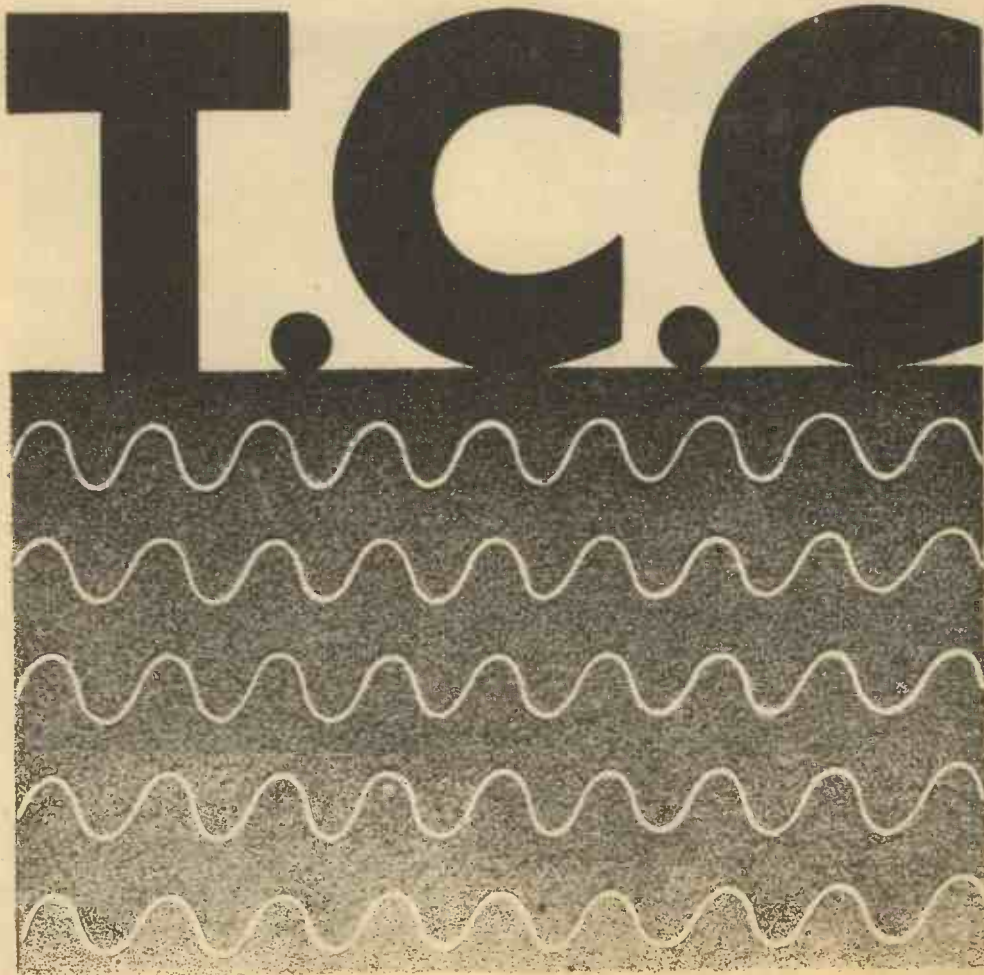

*Pre-eminent in peace,  
indispensable in war*

ADVERTISEMENT OF THE TELEGRAPH CONDENSER CO. LTD.



# SELECTIVITY



## SIMMONDS DOUBLE CRYSTAL FILTER

The paramount importance of high selectivity has long been recognised by radio engineers, but it is only comparatively recently that bandpass filters employing quartz crystal resonators have been made commercially available. After considerable research work our radio laboratory has evolved a new type of crystal bandpass filter employing a pair of quartz crystals, which will be found invaluable in many branches of radio tele-communication. Standard filters are available for frequencies within the range of 440-480 Kcs., having bandwidths of 300 cycles or 3 Kcs. Filters for other frequencies can be made to order. Simmonds crystal filters have an outstanding performance, including a very sharp cut-off and readily adjustable characteristics which make them very suitable for use in the Intermediate Frequency stages of super-heterodyne receivers.



**SIMMONDS AEROCESSORIES LTD**

GREAT WEST ROAD, LONDON.





# The Wireless World

31st Year of Publication  
 Covering Every Wireless Interest  
 MAY, 1941

Proprietors :  
 ILIFFE & SONS LTD.

Editor :  
 HUGH S. POCOCK.

Editorial, Advertising  
 and Publishing Offices :  
 DORSET HOUSE,  
 STAMFORD STREET,  
 LONDON, S.E.1.

Telephone :  
 Waterloo 3333 (35 lines).  
 Telegrams :  
 "Ethaworld, Sedist, London."



**PUBLISHED  
 MONTHLY**

Price : One Shilling

(Publication date 20th  
 of preceding month)

Subscription Rates:  
 Home and Abroad,  
 14/- per annum.

EDITORIAL .. .. .	123
NEW U-S-W FREQUENCY CHANGER. By J. A. Sargrove, F.T.S., M.Brit.I.R.E., N.C.M.E.	124
AUXILIARY DC SOURCE .. .. .	128
BINAURAL TRANSMISSION .. .. .	130
BROADCASTING IN INDIA .. .. .	132
SHORT-WAVE RECEIVING CONDITIONS .. .. .	134
THE WORLD OF WIRELESS .. .. .	136
NEWS IN ENGLISH FROM ABROAD .. .. .	138
ECONOMY IN RECEIVER MAINTENANCE. By "Service" .. .. .	139
LETTERS TO THE EDITOR .. .. .	140
UNBIASED. By Free Grid .. .. .	142
WIDE-RANGE TUNING INDICATOR .. .. .	143
RANDOM RADIATIONS. By "Diallist" .. .. .	144
RECENT INVENTIONS .. .. .	146

Branch Offices :

COVENTRY :  
 8-10, Corporation Street.  
 Telephone : Coventry 5210.  
 Telegrams : "Autocar, Coventry."

BIRMINGHAM :  
 Guildhall Buildings,  
 Navigation Street, 2.  
 Telephone :  
 Midland 2971 (5 lines).  
 Telegrams :  
 "Autopress, Birmingham."

MANCHESTER :  
 260, Deansgate, 3.  
 Telephone :  
 Blackfriars 4412 (4 lines).  
 Telegrams :  
 "Iliffe, Manchester."

GLASGOW :  
 26B, Renfield Street, C.2.  
 Telephone : Central 4857.  
 Telegrams : "Iliffe, Glasgow."



As many of the circuits and apparatus described in these pages are covered by patents, readers are advised, before making use of them, to satisfy themselves that they would not be infringing patents.



## Masteradio

VIBRATORPACKS  
 BRITISH EQUIVALENTS OF  
 AMERICAN TYPES

A SELECTION FROM THE FULL RANGE OF STANDARD VIBRATORPACKS

TYPE	OPERATING VOLTS	CONSUMPTION AMPS.	OUTPUT VOLTS D.C. UNSMOOTHED	OUTPUT M.A.	TYPE OF RECTIFIER
6A300	6	7	300	100	Sync. Vibrator
6B300	6	7	300	100	OZ 4 Valve
12A300	12	3.5	300	100	Sync. Vibrator
12B300	12	3.5	300	100	OZ 4 Valve
VP551	6	6/7	300-275-250-225	100	OZ 4 Valve
VP552	6	6/7	do.	100	Sync. Vibrator
VPG554	12	3/3.5	do.	100	OZ 4 Valve
VPG552	12	3/3.5	do.	100	Sync. Vibrator
VP553	6	4/5	200-175-150-125	100	OZ 4 Valve
VPG553	12	2/2.5	do.	100	OZ 4 Valve

THE PORTABLE POWER SUPPLY FOR RADIO TRANSMITTERS & RECEIVERS.

PUBLIC ADDRESS SYSTEMS.

SCIENTIFIC APPARATUS.

EMERGENCY POWER SUPPLY SYSTEMS.

Used by:  
 The WAR OFFICE  
 The AIR MINISTRY  
 The POST OFFICE  
 and POLICE FORCES.

Proven for long life and reliability under war conditions (in all services, on land, sea and in the air).

Size only 5 3/8" x 4 1/2" x 5 3/8" high and weighing only 6 lbs. approx.

Write for details :—

**MASTERADIO LTD.** VIBRANT WORKS, WATFORD, Herts.

'Grams : MASTIOLA.

'Phone : WATFORD 9885 9890.

*Serving  
the  
National  
Interest-*



**Osram  
Valves**

MADE IN ENGLAND



# The Wireless World

COVERING EVERY  
WIRELESS INTEREST

ESTABLISHED  
1911

Vol. XLVII. No. 1067

MAY, 1941

Price One Shilling

## Makeshifts and Improvisations

### *Maintaining the Broadcast Service*

UNLESS there is a generous increase in the number of components—and especially valves—released for use as replacements in domestic broadcast receivers, servicemen and servicing departments will soon be hard put to it to ensure that the bulk of the public can receive the B.B.C. transmissions. Very rightly, the needs of the Forces come first, and at the best, a shortage of supplies for some time to come seems practically inevitable.

This being so, we must cultivate a new outlook on what is permissible in the maintenance of broadcast receivers. Instead of trying to restore the performance of a defective set to as nearly as possible its original state, it will sometimes be necessary to rest content with something that will do no more than receive the B.B.C. Home Service programme with fair intelligibility. For example, it may, through shortage of replacement valves or components, be necessary to cut out the RF stage of a superheterodyne, or, in extreme cases, perhaps even to eliminate the frequency-changing and IF stages of a set of this type, converting it into a simple detector-AF combination for local-station work.

Much ingenuity will be needed if the best use is to be made of the comparatively few replacement parts that are available, and this journal proposes to print articles giving advice and suggestions for wartime makeshift methods of maintaining receivers—not at the standard we should like, but up to a standard that is sufficient for minimum requirements. Readers who have ideas on the subject or who have devised unconventional methods of overcoming difficulties due to shortage of replacement parts are invited to contribute their suggestions for the benefit of others.

While on this question of minimum requirements,

we submit that the authorities and the industry would be well advised to concentrate such resources as are available on the production of those components and accessories for which, in spite of the greatest ingenuity, substitutes cannot be found. Output valves and power rectifiers are in this category.

#### *Training: Theoretical and Practical*

The position would be easier if an ample supply of well-trained and competent servicemen were available to carry out repair and maintenance work. Clearly, it requires much more fundamental knowledge of receiver technique to improvise a repair than merely to replace every component that is faulty—or suspected of being faulty. This matter should be borne in mind by all who are responsible for the training of those who are to replace the servicemen who have joined the Forces. At times like these there is a tendency, with which everyone will sympathise, to plan intensive courses of training on severely practical lines. But some knowledge of the fundamentals of receiver design will be essential for those who are to maintain the listeners' end of the broadcasting service in the face of a severe shortage of replacement parts. At the same time, it would be worth while giving specific instruction in means of improvising repairs in cases where parts for complete reconditioning are lacking.

It is a minor annoyance, but one we are all ready to face, that these restrictions are beginning to make themselves felt at a time when long-distance broadcasting is becoming more valuable than ever before as a source of news. Those who have high-performance receivers would be well advised to look after them carefully.

# New U-S-W Frequency Changer

## Neutralising Space Charge Coupling in a Parallel Push-pull Circuit

THE use of two valves for the purpose of frequency changing has often been adopted in order to obtain improved frequency stability in ultra-short-wave receivers. In such cases, however, one of the two valves usually performed the mixer function, and the other the oscillator; thus, although segregating the two functions of the

By J. A. SARGROVE, F.T.S.,  
M.Brit.I.R.E., N.C.M.E.  
Chief Engineer—Electro Physical Laboratories, (R. & W.) Ltd.

The 6K8G has a beam type construction, the electron stream being confined in an approximately parallel beam by means of two plates situated close and parallel to the electrode structure and maintained at

accelerator electrode G<sub>4</sub>; this gives ample room for secondary electrons originating in the anode to form a space charge between the anode and the second accelerator barring the way of the secondaries, which would otherwise reach the accelerator electrode when the anode potential is lower than the secondary accelerator potential.

One of the improvements to this type, suggested with a view to enabling it to fulfil radio frequency amplifier applications more satisfactorily, is the inclusion of top and bottom screening elements, such as are normally employed in the structure of RF pentodes. Whilst useful in the following circuit, they are not in this case absolutely essential, due to the totally dissimilar input and output frequencies employed, and also to the automatic neutralisation of space charge fluctuation that occurs in the circuit consequent on arranging the oscillator and output circuits as push-pull systems, and the input circuit as a parallel system.

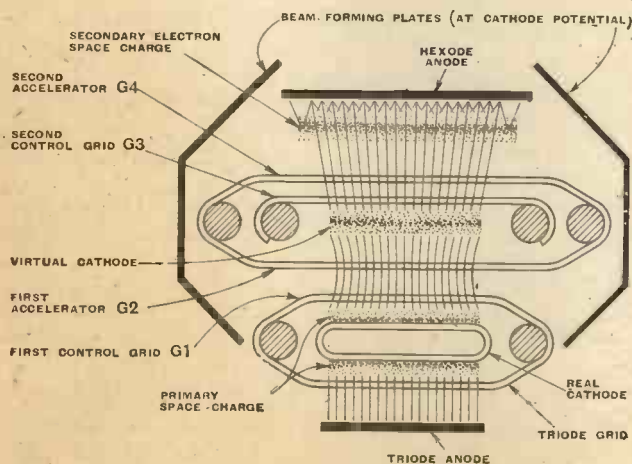

Fig. 1. Schematic diagram of the internal electrode arrangement in the type 6K8G triode hexode.

(Below) Fig. 2. The author's novel ultra-short-wave frequency changer circuit. Special features are parallel input, push-pull (Franklin) oscillator and push-pull balanced IF output.

frequency changer, no particular improvements in the frequency stability of the oscillator *per se* was obtained, though the effects upon the oscillator frequency stability of the varying conditions prevailing in the mixer valve, due to the varying supply voltages, automatic gain control and varying signal strength were eliminated.

To achieve this purpose it is better to use, instead of two dissimilar type valves, two identical triode-hexodes of the type in which the grid G<sub>1</sub> of the hexode is common to the triode grid. The best-known example of this kind of combined valve is the American type 6K8G, which, like the Type 'A' valve, suggested to the Standardisation Committee of the Brit.I.R.E.,<sup>1</sup> will perform in the circuit of Fig. 2 in a most satisfactory manner.

<sup>1</sup> "Rationalising Broadcast Receivers," by J. A. Sargrove. *Wireless World*, July, 1940.

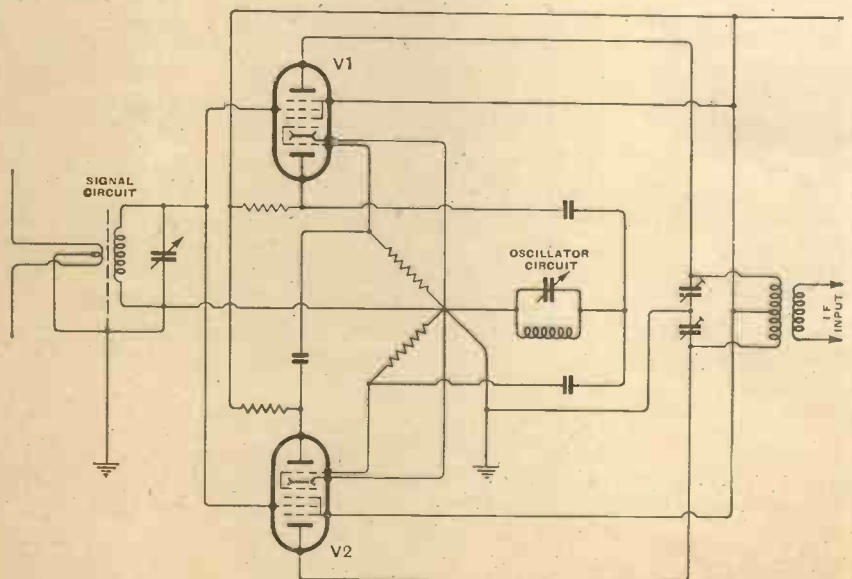

cathode potential (Fig. 1). The anode of the hexode is also at a relatively large distance from the second

To comprehend more fully the arguments that follow, let us recall a few points about the behaviour of



**New U-S-W Frequency Changer—**  
this type of multiplicative frequency changer valve in which the oscillator frequency voltage appears on the first

the space charges between the grids in the form of shaded areas, and at the same time showing a distance-time diagram in which the slope to

uniformity of the potential gradients in the interstices of the grids affecting the electron trajectories within the limits of the electrode potentials, and the initial velocity, in accordance with the laws of probability. The space charge at point Q is also termed the virtual cathode of the hexode.

### Space Charge Movement.

Once the existence of this space charge is understood, it will be obvious that the exact position of the "centre of gravity" of the space charge will depend on the mean kinetic energy of the electrons feeding it, which, in turn, is a function of the first control grid potential, the centre of gravity being nearer to the second control grid (G3) if the first control grid has a potential near to that of the cathode (points B' and B", Figs. 3 and 4), and farther away from the second control grid if this potential has a more negative value (points A, Figs. 3 and 4). When the first control grid potential is equal to the so-called cut-off value of the static grid-volts anode-current curve, this space charge will cease to exist (points C' and C", Figs. 3 and 4). By approaching and receding from the second control grid, the space charge acts as a pulsating variable condenser between G1 and G3.

It can be shown that this virtual condenser has a negative capacitance value of between 1-10  $\mu\mu\text{F.}$ , depending on the mean oscillator grid potential built up by the grid-leak condenser system. Plainly, this varying capacitance will induce into the

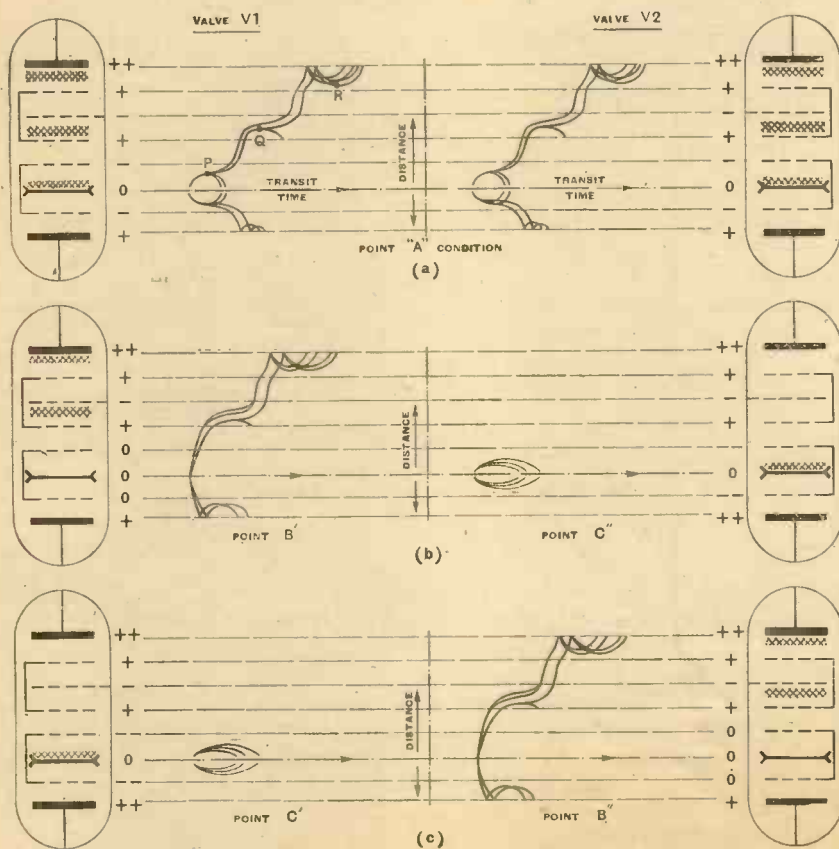

Fig. 3. Time-distance diagrams illustrating electron velocities during one period of oscillation in the pair of 6K8G triode-hexodes used in the circuit. The operating points are explained by Fig. 4.

control grid, whilst the signal frequency voltages are applied to the second control grid, G3. Due to the decelerating action of the negative potential of G3 on the electrons emerging at high speed through the interstices of the G2, an increased electron density occurs between these electrodes. Under certain conditions the decelerating action is sufficient to bring the electrons to rest in this space, from where they can flow either forward to the more remote parts of the hexode or fall backwards into the first accelerator electrode. This accumulation of temporarily stationary electrons is termed a space charge, or virtual cathode.

It is perhaps best to illustrate these phenomena, as in Fig. 3, according to the convention which I have previously proposed and used,<sup>2</sup> showing

the horizontal of the electron path is an index of the instantaneous velocity of the electrons, the horizontal axis being transit-time. From the distance-time diagram it will be manifest that a horizontal part of the electron progression curve indicates electrons momentarily at rest. For instance, points P and Q on the curve represent such states. It will be seen also that at these points some electrons are still moving forward, whereas others are already returning, this being due to the Maxwell distribution of velocities of the original electron emission from the cathode, as well as to the variation in electron speeds occurring due to the non-

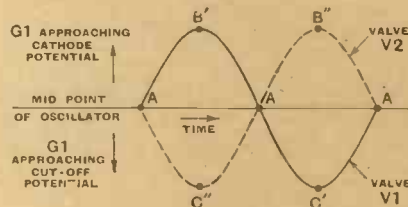

Fig. 4. Phase relationship of the first control grid voltages of the pair of triode-hexodes used in the circuit during one period of oscillation. Points A, B', B'', C' and C'' are also referred to in Fig. 3.

second control grid circuit an oscillating voltage which, in turn, will cause an oscillating current to flow through the input circuit. The fre-

<sup>2</sup> "Parasitic Oscillation in Frequency Changers" by J. A. Sargrove. *Wireless World*, August 10, 1939.

**New U-S-W Frequency Changer—**  
 frequency of this induced voltage is identical with the first control grid (oscillator) frequency, but its phase relation thereto depends on the reactive character of the input circuit. This induced voltage is in quadrature to the inducing current, only when the input circuit is purely resistive, i.e., its resonant frequency is exactly the same as the actual oscil-

lating-plate oscillator. In the above the locking does not occur when the two circuits are in exact tune as in the latter circuit, but, on the contrary, the locking takes place when the input circuit is slightly inductive with reference to the oscillator frequency.

A simple single-valve triode oscillator, whether of the Hartley or Colpitts type, has considerable fre-

coupling, whilst the Colpitts oscillator, due to capacitive coupling, works at a higher frequency than the resonant frequency.

### Oscillator Frequency.

A slight delay is caused in the Franklin regenerative coupling by the electron transit time in the two triodes. On extremely short waves

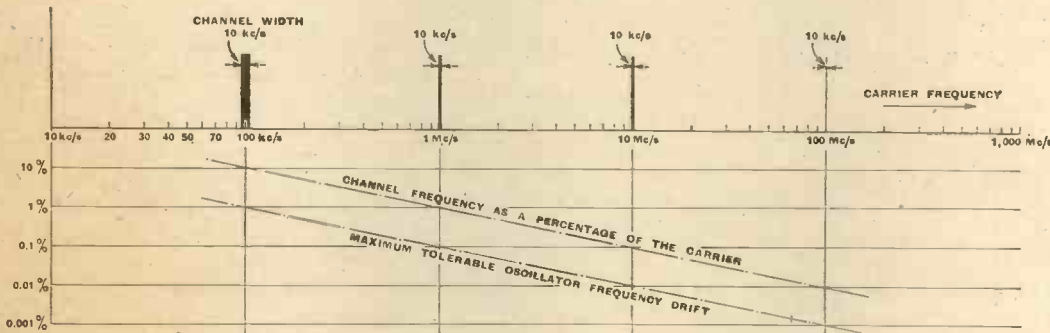

Fig. 5. Diagram showing channel width as a percentage of carrier frequency and maximum tolerable oscillator drift based on the assumption that loss of intelligibility is appreciable at 10 per cent. of channel width.

lator frequency. On all other frequencies the phase relationship leads or lags behind the quadrature condition, depending on whether the input circuit is inductive or capacitive to the oscillator frequency.

### Transit Time Effects.

On short-waves, due to transit-time effects, space charge coupling can be detrimental, as, even if the input circuit is resonant to the oscillator frequency, a lag in the induced voltage will occur. The lagging second control grid voltage will cause a decrease in the mean anode current, and a leading induced voltage an increase. The decreasing anode current will at the same time produce a decreasing conversion conductance of the whole frequency changer, whilst an increasing anode current would cause an apparently increasing conversion conductance, which is, however, largely unusable owing to spontaneous self-oscillation that will occur.

The self-oscillation is due to the decreasing phase angle between the first and second control grid voltages causing a locking action, though one must be careful not to confuse this with the locking action that occurs in an unneutralised triode R.F. amplifier stage, or Huth-Kühn oscillator, better known as a tuned-grid

frequency drift as a consequence of varying anode supply voltage and varying cathode space charge position, which, in turn, depends on cathode temperature variations. This trouble is particularly marked on very short wavelengths as the channel width of an individual station is such a very small percentage of the actual station frequency that a very small percentage oscillator frequency drift will completely lose the desired station and bring in other unwanted channels in turn. (See Fig. 5.)

The double-triode Franklin oscillator embodied in this new circuit removes all these troubles, as its stability is of the same order as a crystal controlled master oscillator. This exceptional stability is due to the minute coupling capacitors required between the basic tuned circuit and the valves which makes any variation in valve capacitance negligible. This fact is generally known, but what is not usually realised is that due to the fact that two point coupling to the tuned circuit is employed instead of three required in the Hartley or Colpitts arrangements, the Franklin circuit oscillates theoretically at a frequency much closer to the resonant frequency of the tuned circuit.<sup>3</sup> The Hartley circuit works at a lower frequency due to its inductive

this will make itself felt, and hence the circuit will oscillate at a lower frequency than resonance. Whilst having a failing similar to the Hartley, it must be stressed that the order of magnitude of the trouble is smaller, due to the aforementioned very small coupling condensers. On short waves in a Hartley circuit the frequency drift is due not only to the lagging regenerative coupling but also due to the close coupling shunting the circuit by the varying valve impedance. This latter factor is clearly not of any importance in the Franklin oscillator due to the extremely loose coupling employed. Thus we have a net advantage and are left with the main residual cause of frequency drift which is variation in the value of inductance and capacitance of the basic oscillatory circuit, due to temperature change, etc., which can be minimised by well-tried methods. In no case would coil or condenser effects be comparable with those caused by valve characteristic variations in the single-valve oscillator.

In addition to having a high order of frequency stability the use of a twin triode Franklin oscillator in this new frequency changer has these

<sup>3</sup> "Theory and Design of Valve Oscillators," by Dr. H. A. Thomas (Chapman and Hall).



## Wireless World

### New U-S-W Frequency Changer—

advantages. The individual grids of the two triodes in the basic Franklin oscillator are individually coupled to the oscillator injector grids of the two hexodes, hence the space-charge-induced voltages on the respective signal input grids of the two hexodes will be out of phase. It is obvious that if the two input grids of the hexodes are connected to the input resonant circuit in parallel, then the space-charge-induced voltages will partly cancel out. To improve this cancellation the two triodes themselves should be so coupled that their grid voltages are identical or very similar. This can be done by careful design of the coupling condensers and resistances. Under these conditions we can consider the deleterious space charge coupling to be satisfactorily neutralised.

This effect can be more clearly seen if we examine the phase relationship which occurs in the two triode-hexodes of the circuit Fig. 2, illustrated in Fig. 3, in relation to the oscillator period shown in Fig. 4.

From this it will be seen that opposite conditions prevail in the two valves at each portion of the oscillator cycle. Clearly this measure completely obviates the locking effect without having to resort to neutralising circuits or other artificial means.

### Output Filtering.

The input system is in parallel, whilst the oscillator system, though actually in cascade, can be considered in push-pull from the point of view of the mixer system, the grids being in opposite phase. Consequently the AC anode currents of the two hexodes will flow in opposite phase to each other. This is a very agreeable incidental feature. It enables us to obtain easily a cancellation or elimination of the input frequency, as well as the oscillator frequency in the first IF transformer, by the simple expedient of connecting a relatively small condenser from anode to anode of the two hexodes. The most convenient arrangement is that shown in Fig. 2, where a centre-

tapped anode coil is used. The IF tuning condenser is split into two condensers in series, the centre tap being earthed, thus producing a simple filter circuit. This filter removes practically all traces of the higher frequency components of the anode currents.

In constructing this novel U-S-W frequency changer, the usual short wiring is essential as well as very careful and intelligent layout. If the remainder of the circuit is well designed, the normal commercial 6K8G valve can be used up to frequencies of the order of a hundred megacycles. At first sight this may seem a surprising result as the valve in question has a normal bakelite base, and thus is subject to the usual leakage troubles. However, in the ordinary type of simple mixer circuits, leakage was usually blamed for much graver troubles which occurred in the long electrode leads between the valve proper and the valve pins. Due to the automatic neutralisation described above many of these detrimental couplings are rendered innocuous, and hence the satisfactory results are more or less automatically achieved.

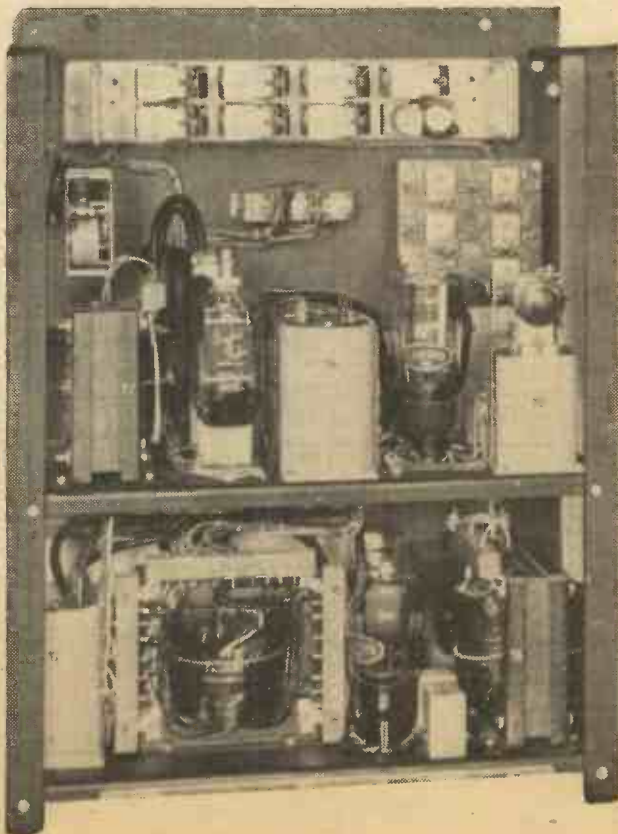

### RIPPLE CONTROL TRANSMITTER

This apparatus has been developed by the G.E.C. for switching on and off electrical apparatus by means of LF impulses superimposed on AC power mains. A valve oscillator provides the necessary power of 150 watts, six control frequencies between 380 and 550 c/s being generated. The receiver consists of a series of reeds tuned to the various frequencies, these reeds operating mercury switches through gear mechanism. The system is mainly intended for use in factories and other places where three-phase supply is available, and is, at present, largely used for distributing air raid warnings.

### From the World's Technical Press

AT such a time as this the wireless engineer might well feel cut off from the world, so far as a knowledge of the advances in wireless technique are concerned, were it not for such a service as that rendered by the Radio Research Board in compiling the Abstracts and References section of *The Wireless Engineer*.

In the April issue nearly 300 articles recently published in the world's technical Press are abstracted or referred to in this monthly feature of our sister journal. Whilst important articles in English, in a journal likely to be readily accessible, may be dealt with by a parenthetic addition to the title, a page or more is frequently devoted to an article of similar importance appearing in a German or Italian journal.

In addition to this section and a summary of recently accepted patent specifications, the April issue contains articles on receiver aerial coupling circuits, the ganging of superheterodyne receivers and feedback amplifier circuits.

Published on the first of the month, *The Wireless Engineer* is obtainable to order through newsagents, or direct from our publishers at Dorset House, Stamford Street, London, S.E.1, at 2s. 8d., including postage.

# Auxiliary DC Source

## —And Some of Its Applications

The need for an auxiliary source of DC potential often arises in experiments with receivers, but the cost of a supply unit of conventional design is not always justified. This article describes how the necessary potential can be obtained inexpensively, and also shows many ways in which it can be used.

IT will be assumed—as indeed should be fairly obvious—that only a small current will be drawn from the auxiliary supply circuit to be described in this article. Fig. 1 shows how an ordinary rectifier unit, conventional except that in this case choke input smoothing is employed, may be modified to provide an auxiliary supply, negative with respect to earth. Any spare

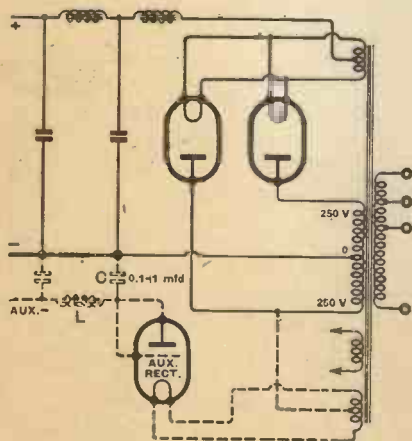

battery valve will suffice for this auxiliary rectifier. The output voltage can be adjusted from about 150 volts to 350 volts by selection of the capacity C;

Fig. 1.—Connections of an auxiliary supply circuit (in dotted lines) added to a choke-input rectifying system.

the higher the capacity the higher the resultant voltage. In the interests of valve life it is advisable to use the smallest capacity and hence lowest voltage sufficient for the designer's needs. If no spare filament winding is available on the transformer, it is possible in some cases to wind a small quantity of thin wire on top of the existing windings, sometimes without even dismantling the core. Alternatively, a "bell-type" transformer, which can be obtained for a few shillings, can be used. If the current drain on the auxiliary supply is very small, the smoothing choke L may be replaced by a resistance.

Turning to the uses to which an auxiliary source of DC supply may be put, we will first suppose that means are required for balancing the anode currents in a push-pull output stage. One way of doing this, shown in Fig. 2, does not call for any auxiliary supply. The currents may be equalised by adjusting the slider of R1, and when bias is reduced on one valve it is increased on the other. If the variation of bias required be plus or minus 1 volt, and the HT 250 volts, then suitable values

for the resistances are  $R_1 = 10,000$  ohms, and  $R_2$  and  $R_3 = 1.25$  megohms (say 1 megohm to use the nearest commercial value). Other values in the same proportion

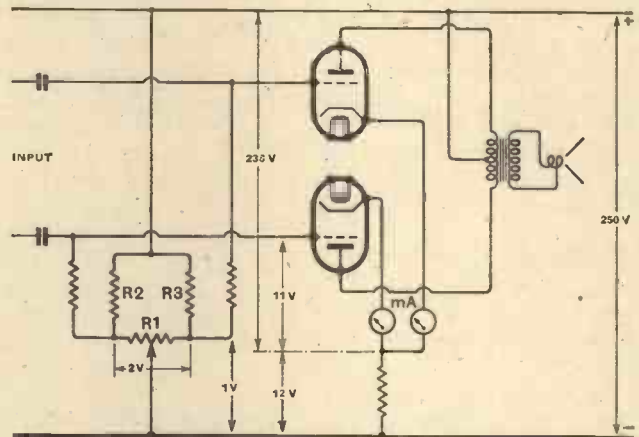

Fig. 2.—Balancing a push-pull output stage by a method which does not call for an auxiliary source of grid voltage.

may be used. Greater variations than plus or minus 1 volt are often required, in which case either  $R_1$  should be proportionately increased or  $R_2$  and  $R_3$  proportionately decreased.

One disadvantage of this circuit is that as the grids are biased positively with respect to earth, the cathodes must be given an extra positive bias by the same amount. Unfortunately, this is effectively subtracted from the HT volts available for the valve.

This disadvantage may be overcome by using an

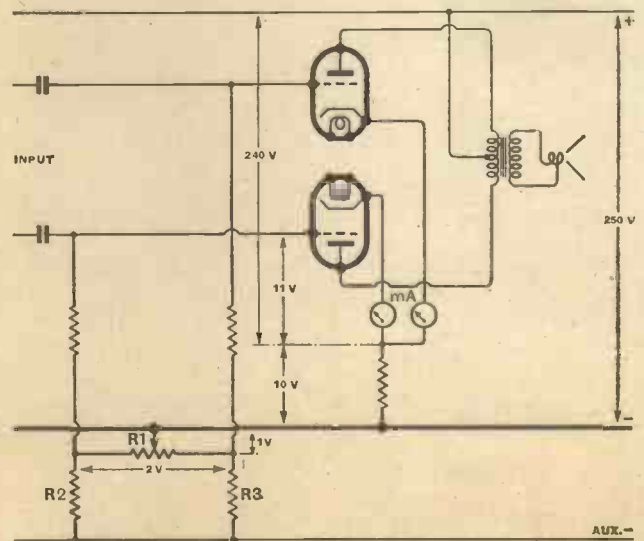

Fig. 3.—Method of balancing the output stage, by means of an auxiliary source of bias.



## Auxiliary DC Source—

auxiliary supply, negative with respect to earth. Fig. 3 shows the circuit of Fig. 2 adapted so that the main bias is taken from the HT supply, while the variable portion is taken from the auxiliary supply. Notice that the cathodes require less positive bias to earth than is necessary in the simple auto-biased circuit.

Supposing that there are no spare volts available from the HT system for biasing purposes. Then all bias may be obtained from the auxiliary supply, as shown in Fig. 4. Here  $R_4$  is the main bias resistance and with the values previously suggested 10 volts main bias will be obtained if  $R_4 = 25,000$  ohms. At this point it should be emphasised that the bias produced by  $R_1$  is *additional* bias at both ends, so that when the slider is in the centre point both valves will receive 11 volts bias, but either may be biased to 12 volts whilst the other be biased to 10 volts by moving the slider to either end.

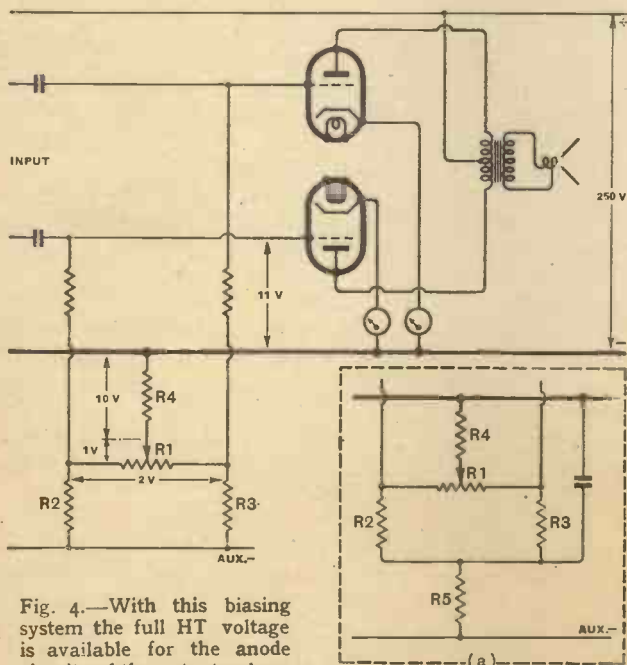

Fig. 4.—With this biasing system the full HT voltage is available for the anode circuits of the output valves.

The inset diagram (a) shows the addition of a decoupling resistance and condenser.

If a change-over from auto-bias to independent bias be made, however, one should not forget that the total permissible external grid-to-cathode resistance is reduced to about 50,000 ohms per valve. When using the circuit of Fig. 4 the grid leak resistance plus the value of  $R_1$  plus twice the value of  $R_4$  should therefore be not greater than 50,000 ohms. The value of  $R_4$  should be doubled because it is in the grid circuit of both valves.

It sometimes happens that the auxiliary supply is used for several purposes, when it may be desirable to decouple the grids from the auxiliary supply. One may achieve this by connecting high-capacity low-voltage electrolytic condensers from each end of  $R_1$  to earth, or by the more conventional circuit of Fig. 4 (a).

A second use for the auxiliary supply is in connection with single-valve phase-splitters. Two common difficulties in the design of these are to avoid overloading,

and to avoid a large difference of potential between the heater and the cathode of the phase-splitter valve. Both difficulties may be overcome by the use of an auxiliary supply, as shown in Fig. 5. Here the valve is utilising the full voltage between HT

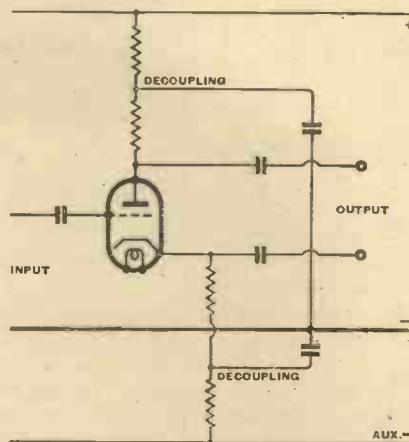

Fig. 5.—Auxiliary voltage supply to a phase-splitting valve.

positive and auxiliary negative, thereby reducing considerably the dangers of overloading. In order to lighten the load on the auxiliary supply, all resistances should be made as high as is consistent with other considerations. By suitably proportioning the anode and cathode coupling and decoupling resistances, the cathode potential may be brought just sufficiently above earth to provide the bias for the valve.

A third use for an auxiliary supply is in connection with the AVC amplifier used with the negative feed-back detector previously described in *The Wireless World*. It may be remembered that this detector imposes very little load on the tuned circuit and the AVC voltage developed is almost independent of the degree of modulation.

Fig. 6 shows the circuit, complete with decoupling. The decoupling resistance values should be small compared with the coupling resistance values in order that the ratio between the AC and the DC loads be made close to

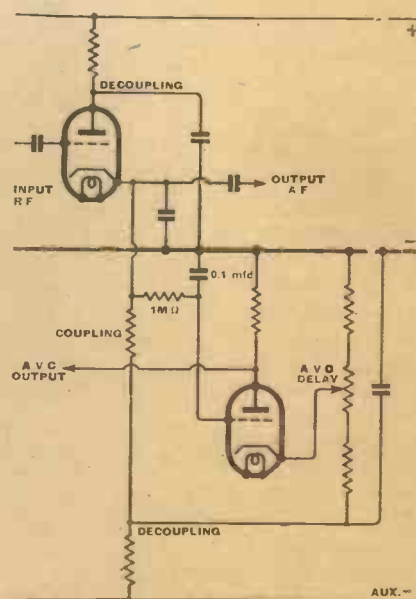

Fig. 6.—Method of feeding an AVC amplifying valve.

unity, and distortion be avoided at high modulation.

Many other uses for the auxiliary supply will doubtless occur to the experimenter, such as 'paralysing' the AF amplifier in QAVC circuits. In happier days it may prove useful in connection with DC-coupled vision-frequency amplifiers.

R. C. W.

# Binaural Transmission

## Combining Frequency and Amplitude Modulation with a Single Carrier

THE quest for perfection in quality of reproduction has travelled far along the track of single-channel transmission. Consistently good results are obtained from modern quality loudspeakers in conjunction with amplifiers of wide-frequency response and low harmonic distortion, but occasionally the quality enthusiast is treated to a programme of outstanding excellence having that touch of realism and perspective which is normally lacking in everyday programmes.

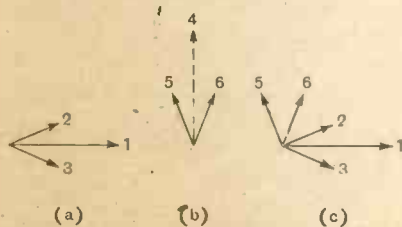

Fig. 1. Phase relationships of carrier and sidebands in the combined frequency and amplitude modulated transmitter. (a) Carrier and amplitude modulated sidebands. (b) Frequency-modulated sidebands (carrier suppressed). (c) Combined output from the two modulators.

When this happens it will usually be found that there is a long reverberation time in the hall or studio where the original performance is taking place. Sounds are arriving at the microphone more than once and in different phases, and we are, in fact, being given a foretaste of the type of quality that true binaural transmission might provide.

The practical difficulties of transmitting two or more separate channels in the correct phase for producing "stereophonic" sound effects have long since been solved satisfactorily, and readers will no doubt remember the classical demonstration in 1933 arranged by Dr. Harvey Fletcher in collaboration with the Bell Telephone Laboratories and the Philadelphia Orchestra under Leopold Stokowski. The obstacle to the realisation of a binaural broadcasting service has been the difficulty of finding space in a frequency spectrum already over-

crowded by single-channel "monaural" transmissions.

A system for transmitting two audio channels on the same carrier would solve the problem, and an ingenious method has been put forward recently by A. V. Eastman and J. R. Woodyard.<sup>1</sup>

The basic principle is explained in simple terms by the diagrams of Fig. 1. A normal amplitude-modulated signal may be represented as in Fig. 1 (a) by a carrier vector 1 and two sideband vectors 2 and 3. If the carrier vector, which revolves counter-clockwise at constant velocity were stopped at every revolution in the position shown, the vector 2 representing the upper sideband, thus increasing the angle, and 3, representing the lower sideband, would have lagged by a similar angle. These two sideband vectors can, therefore, be visualised as revolving symmetrically in opposite directions about the main vector 1. When applied to a normal detector preceded by a symmetrically tuned circuit the two audio components resulting from the interaction of sidebands 2 and 3 with the carrier are additive and will provide one channel of the binaural system.

The other channel is associated with sidebands 5 and 6; Fig. 1 (b), which are developed in the transmitter about a carrier 4 which is sup-

Fig. 2. Illustrating the principle involved in the reception of the frequency-modulated channel.

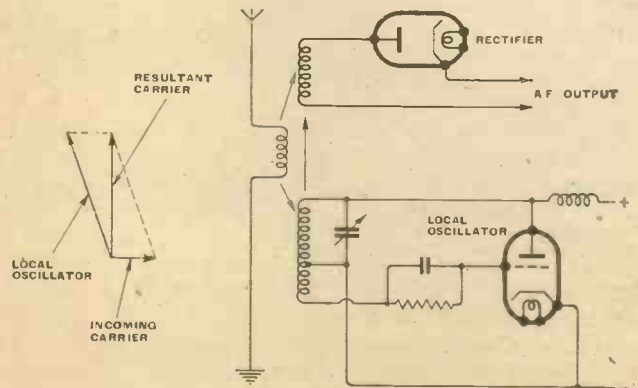

pressed in a balanced modulator, but whose phase would be always 90 degrees in advance of the main carrier 1. The vector relationship of

the components of the complete signal are depicted in Fig. 1 (c).

Due to the phase shift of 90 degrees from the carrier 1, the interaction of sidebands 5 and 6 produces audio components which are in opposite phase and will cancel in the normal detector circuit. They can, however, be made to produce their original audio frequencies by the artificial introduction of a carrier in the proper phase, and this is accomplished by advancing the phase of the received carrier by 90 degrees in a special receiver which then automatically becomes deaf to the modulation in the channel represented by sidebands 2 and 3.

Before conversion, the relationship between the carrier 1 and the sidebands 5 and 6 is closely analogous to a frequency modulated wave in which the frequency swing is small compared with the applied audio frequency. In fact, the method of reception used for this channel is one which has been employed for frequency modulation<sup>2</sup>, and the fundamental circuit is given in Fig. 2.

The local oscillator is tuned to the same frequency as the incoming carrier and the coupling to the aerial circuit is adjusted until the oscillator

locks with the carrier at a phase angle of more than 90 degrees. The

<sup>1</sup> "Application of the Autosynchronised Oscillator to Frequency Modulation." by J. R. Woodyard, *Proc. I.R.E.* May 1937.



exact phase angle required is determined by the relative amplitudes of the oscillator and the incoming carrier at the rectifier and is adjusted until the resultant phase angle is 90 degrees from the incoming carrier.

of the detector input circuit is high a damping resistance may be required to ensure that the detector does not respond directly to frequency modulation which would result in the introduction of some

second audio channel are not unduly complicated. A schematic diagram is given in Fig. 4 and it will be seen that the output from the second microphone is applied to a balanced modulator which suppresses the carrier and leaves the sidebands, which subsequently pass through one of two alternative types of phase-shifting network before mixing with the output from the existing amplitude modulator. The band width of the combined transmitter is no greater than that required for single channel operation.

A demonstration of the system has been given at the University of Washington in collaboration with Mr. E. D. Scott, and the results obtained showed that the scheme is quite practicable. The tests were made as part of a series of investigations into the problems of frequency modulation and the modulation system differed slightly from the method originally proposed. Nevertheless, good separation between the channels was obtained, the background of one system being about 30 db. down on the other. Working along these lines we see

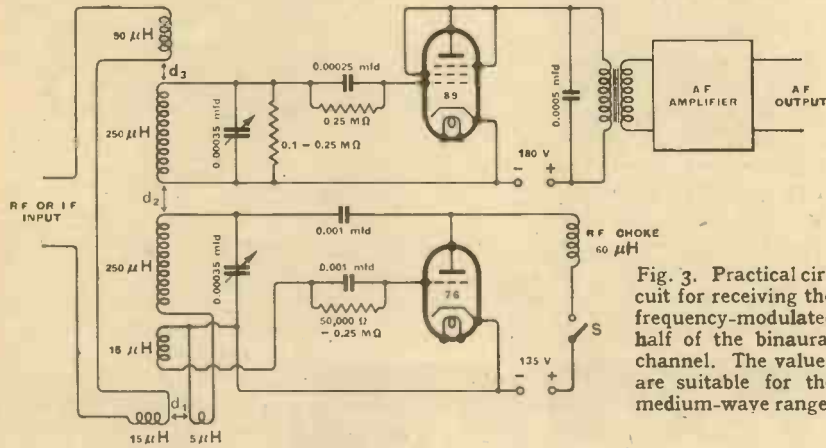

Fig. 3. Practical circuit for receiving the frequency-modulated half of the binaural channel. The values are suitable for the medium-wave range.

The sidebands 5 and 6 are now in the same relationship to the carrier as 2 and 3 were in the normal receiver. Hence their interaction will produce an audio output and the product of 2 and 3 will be rejected.

A practical circuit with values suitable for RF amplification on the medium-wave band is shown in Fig. 3. The grid detector is a pentode with triode connections and the oscillator is a general-purpose triode. Coils are wound on formers of the same diameter and are mounted coaxially with adjustable couplings.

In setting up the circuit the distance  $d_1$  between the aerial and oscillator coupling coils is first adjusted so that the oscillator locks-in over the desired frequency range.

The oscillator grid leak also has some influence on this adjustment. Next,  $d_2$  is varied until, with no incoming signal the RF voltage on the detector grid reaches the value indicated by the vector relationship of Fig. 2. In practice a value from 3 to 10 times the strongest signal received will be required. If the Q

second harmonic distortion. A further adjustment of carrier phase is available in the coupling  $d_3$  which controls the magnitude of the direct RF input to the detector.

The provision of an oscillator switch S enables the set to be changed from frequency-modulated

Fig. 4. Schematic circuit diagram of modulator stages in the binaural single RF channel transmitter.

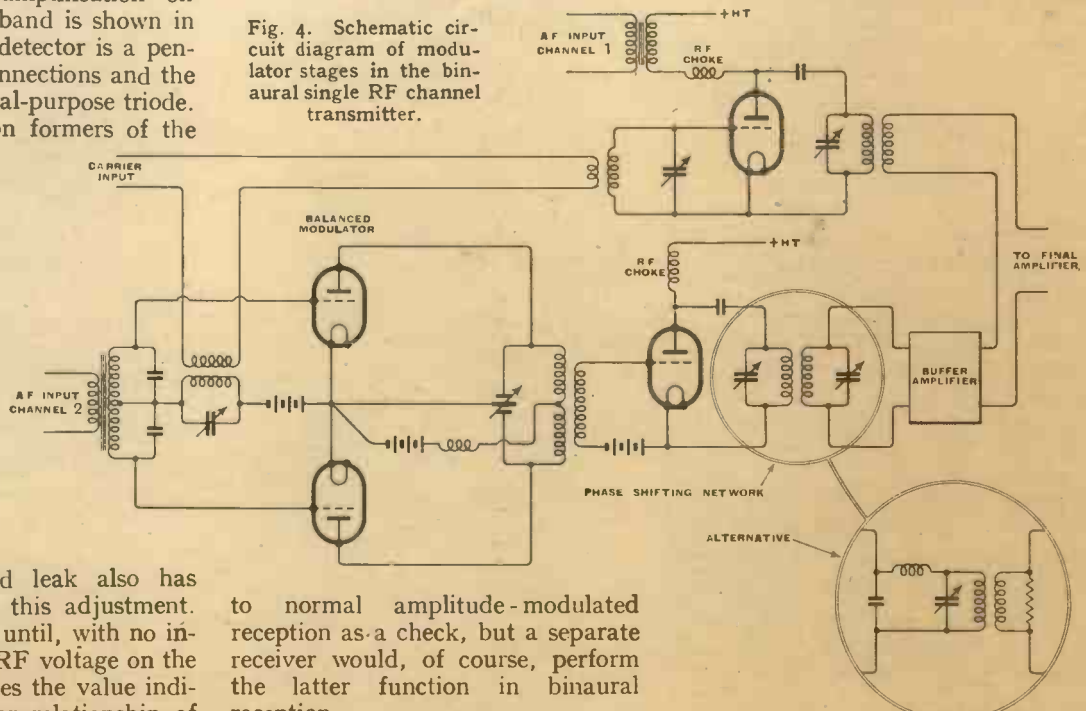

to normal amplitude-modulated reception as a check, but a separate receiver would, of course, perform the latter function in binaural reception.

At the transmitter the modifications necessary for the addition of the sidebands associated with the

no technical reason why an experimental binaural broadcasting service should not be established.

# Broadcasting in India

## A Survey of its Development

**T**HE history of broadcast development in India is a story of steady progress in spite of what at first appears to be insurmountable difficulties. These difficulties, which are peculiar to the Indian Empire, include the extremely high atmospheric disturbance level; the vast, widely scattered population; the multiplicity of languages spoken, and the illiteracy of its people.

Prior to relinquishing his post as the first Controller of Broadcasting in India, Mr. Lionel Fielden, who was recently made a Companion of the Order of the Indian Empire, issued the first annual report on the activities of All India Radio, and, since no separate report on Indian broadcasting had previously been issued, he included an historical survey of its development. We therefore take the opportunity of recording its growth as given in the report, which is published by the Manager of Publications, Government of India, Delhi, at Rs. 3 (5s.), and occupies some 250 pages, plus numerous maps, graphs and circuits.

Although there had been a broadcasting service in the Madras Presidency since 1924, the history of organised broadcasting in India begins in July, 1927, when Lord Irwin (now Lord Halifax); then Viceroy, inaugu-



Symbolic of the modern design of Indian medium-wave stations is this view of the transmitting building and 180 ft. self-radiating mast of the Trichinopoly station. The mast is surmounted by a "capacity top" to increase its effective height.

rated the first transmitter of the Indian Broadcasting Company. This medium-wave 1.5-kW station was situated in Bombay. In just over a month the second 1.5-kW transmitter was opened in Calcutta. The effective service range of each of these stations was about 30 miles, which fact accounts for the number of licences in force at the end of 1927 being little more than 3,500.

Within a year the number of

licences had risen to over 6,000, but the increase thereafter was very slow, and by the end of 1932 the number of licence holders was only 8,500. There were still only two stations operating. In 1932-33, however, there was a sudden increase, the total at the end of 1933 being nearly 11,000 and a year later 16,000. The sudden increase is attributed in the report to the opening of the B.B.C. Empire Service in December, 1932, and the consequent purchase of sets by a large number of Europeans in India.

### Apparent Failure

It was in 1930 that the original Indian Broadcasting Company went into liquidation, and it seemed, therefore, that broadcasting in India had failed. It is suggested in the report that the failure may, perhaps, be ascribed to four reasons which, in part, still hold good to-day. First, the lack of funds, secondly the very high price of receivers (about Rs. 500 [£37 10s.] for a four-valve set), thirdly that Indian conditions were by no means as favourable to the rapid growth of broadcasting as those of the West and, lastly, there was difficulty in collecting the Rs. 10 annual licence fee (of which the company took 80 per cent., in addition to a 10 per cent "tribute" on the value of all imported receivers).

Broadcasting was taken over by the Government of India in 1930, and the two existing stations were operated as the Indian State Broadcasting Service. After many vicissitudes, during which independent States had started schemes for the establishment of their own broadcasting services, the Government put the broadcasting



The task of changing to any desired wavelength between 25 and 90 metres can be carried out in less than ten minutes with the Philips 10-kW short-wave transmitters in use.



## Wireless World

### Broadcasting in India—

service on its feet in 1935 and appointed Mr. Lionel Fielden as the first Controller of Broadcasting. The following year saw the opening of a 20-kW medium-wave station at Delhi, and the arrival of Mr. H. L. Kirke, of the B.B.C. Research Department, to study the situation with the Controller, and to report on a scheme for the expansion of the service.

Toward the end of 1936 a member of the B.B.C. engineering staff, Mr. C. W. Goyder, who was a well-known amateur transmitter in the early days of wireless, was, in accordance with Mr. Kirke's recommendation, appointed chief engineer of All India Radio, as the broadcasting service was then called.

Mr. Goyder still holds that position.

So far as readers of *The Wireless World* are concerned, the most interesting facts about the development of broadcasting in India are to be culled from Chapter V of the report which deals with the engineering and technical aspects.

### Short-wave Network

The report makes it clear that the area covered by a direct-ray service from the medium-wave stations at present planned will only represent a small fraction of the total area of India. The limitation to the indirect-ray service area of the medium-wave stations is atmospheric disturbance. These considerations, together with the fact that the indirect-ray service area of a short-wave transmitter is much greater, and it can also provide an indirect-ray long-distance service during daylight as well as after dark, led to the establishment of four 10-kW short-wave stations so disposed that the whole of the country is given a second-grade broadcasting service under normal conditions. These stations are situated at Delhi, Bombay, Madras and Calcutta, and each has a normal effective range of 500 miles.

The provision of these stations is but the initial step in the development scheme for covering the country. As short-wave transmissions are unreliable owing to fading, it is hoped eventually to build additional medium-wave stations to give a direct-ray service throughout the country. This, however, would incur a capital expenditure of approximately 10 crores of rupees (£7,500,000).

In sharp contra-distinction to the general purpose of a short-wave service, the Indian stations are intended to serve the country in which they

are located, and not oversea. To provide a service from a short-wave station in the area in which it is located, it is necessary to employ a wavelength which does not produce a "skip-distance" zone around the station. Field-strength measurements made prior to the inauguration of the Delhi short-wave station showed that the best night-time wavelength was around 90 metres. Later measurements indicated that a wavelength of the order of 60 metres was more satisfactory for the early summer months. For daylight transmissions 31 metres is used.

In order to minimise skip-distance troubles over relatively short distances, special attention had to be given to the angular radiation char-

acteristics of the aerial system which should give roughly uniform radiation in all angles, both in the vertical and horizontal planes. After exhaustive tests, it was finally decided to employ a half-wave horizontal dipole erected

half a wavelength above the earth. In addition to the four 10-kW and one 5-kW short-wave transmitters and the four 5-kW and one 0.25 kW medium-wave transmitters originally planned, it will be seen from the sketch map that All India Radio also operates a few other stations which have been taken over from various organisations. A number of stations are also operated by the self-governing States.

In the development scheme it was agreed to erect a number of receiving centres. The first of these to be put into service is located at Todepur, on the outskirts of New Delhi, and the others to be erected at each of the transmitting stations will be on similar lines. These diversity re-

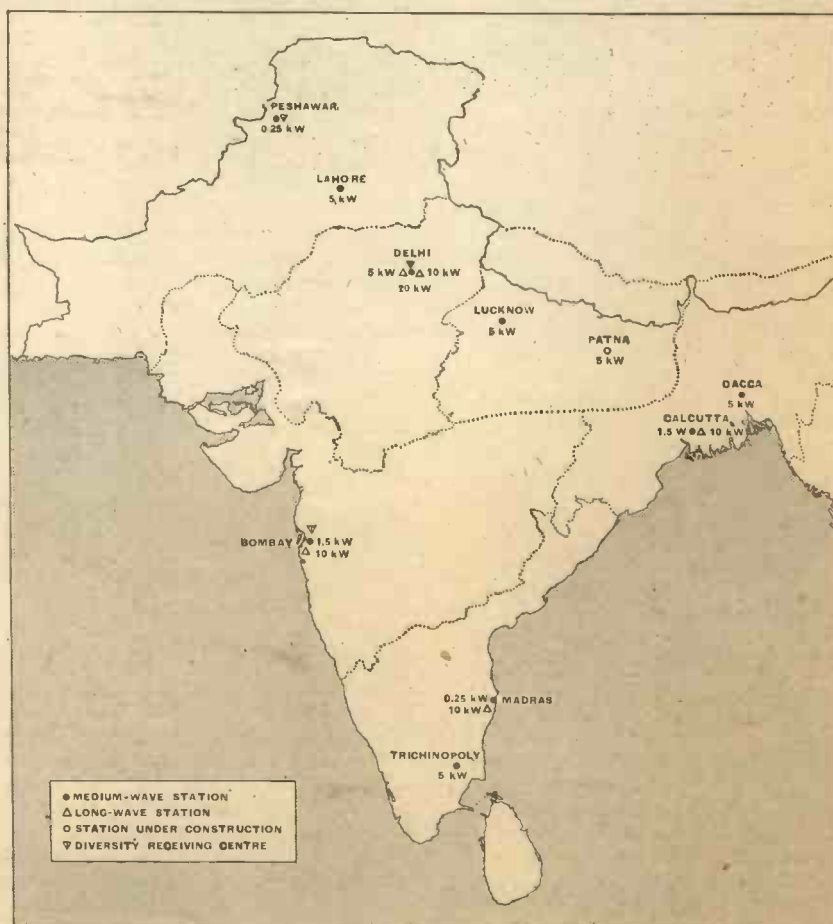

All India Radio development scheme showing the disposition of the 14 stations at present in use and the areas they serve.

acteristics of the aerial system which should give roughly uniform radiation in all angles, both in the vertical and horizontal planes. After exhaustive tests, it was finally decided to employ a half-wave horizontal dipole erected

ceiving centres are intended not only for relaying transmissions from oversea, but also from A.I.R. stations, as existing telephone circuits are unsuitable for linking the transmitters.

For these receiving centres the

### Broadcasting in India—

Eruce horizontal rhombic aerial has been adopted as a standard. Two rhombic aerials are normally used in conjunction with a third which, depending on prevailing conditions, may be a horizontal doublet, an inverted "V," or a vertical aerial.

The receiving equipment comprises four rack-mounted sets, three of which are normally used for a relay, whilst the fourth is kept as a standby tuned where possible to another transmitter radiating the same programme. To avoid mutual interference between the beat oscillators of each

The standard village receiver which is housed in a sheet-metal box.

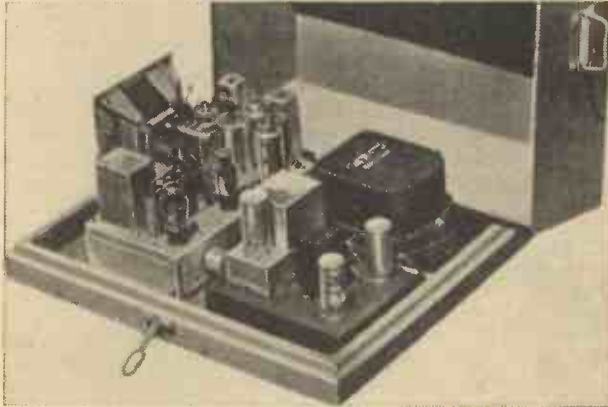

receiver when more than one is tuned to the same frequency, the IF stages of the four receivers are adjusted to have mid-band frequencies of 430, 445, 460 and 475 kc/s respectively (in later receivers the separation has been increased to 20 kc/s).

In addition to its function as a receiving centre, the Todapur station serves as a wavelength checking centre.

In a country like India where there are some 700,000 villages, and where 90 per cent. of its people are illiterate, even to the extent of being unable to write their own names, the sociological aspects of broadcasting present extremely difficult problems.

### Communal Listening

It was realised that even the simplest type of short-wave receiver, costing about Rs.100, was within the reach of not more than one per cent. of the population, and that the only way to make wireless available to the bulk of the population was by the use of community receivers.

The experiments made up to the end of 1939, when there were fewer than 200 community sets in use, have, for various reasons, however, been limited and spasmodic.

The recommended receiver, which costs Rs.300 complete, is a superhet covering all the broadcasting bands in use in India. A frequency changer is followed by one IF stage; a double-diode-triode for detection, AVC and

AF amplification; a driver; and, lastly, a double-triode output valve working in Class B. The IF transformers are of the iron cored type in which adjustments are made by sliding the core. Experience showed that in conjunction with fixed condensers for tuning these provide better stability than is obtainable with variable trimming condensers.

Power is derived from a 6-volt car-

type battery and vibrator. In the interests of frequency stability, directly heated valves are used in the mixer and IF stages; elsewhere indirectly heated types are employed, as they give greater freedom from hum due to the HT generator.

The receiver is designed for a maximum output of 3 watts to the loudspeaker, which, incidentally, has itself

been a source of trouble. The choice of loudspeaker is practically restricted to the permanent magnet type, and during the S.W. Monsoon the speech coils and cones tend to become distorted unless special precautions are taken.

A time switch is fitted to the receiver, which is enclosed in a metal box. The time switch was found to be necessary because in some villages the receivers were used for longer periods than intended with the result that the battery had run down long before battery replacement was due, whilst in other villages programmes were missed because the receiver was not switched on in time.

By far the most serious limitation to short-wave reception in India is the interference resulting from the use of DC for the operation of ceiling fans, which, during the summer months, are in use for the greater part of the 24 hours. Proposals for the compulsory use of suppressors are being considered.

It will be seen from the foregoing that the development of broadcasting in India is subject to many difficulties, not the least of which is a lack of funds to provide an adequate service. It is noteworthy that the Rs.40 lakhs (£300,000) originally allocated for the development of broadcasting over an area thirty times that of the British Isles with a population of more than 350,000,000 is less than the amount available for providing a television service for the London area.

## Short-wave Receiving Conditions

### PROSPECTS FOR MAY

(COMMUNICATED BY THE ENGINEERING DEPARTMENT OF  
CABLE AND WIRELESS, LTD.)

SHORT-WAVE receiving conditions were erratic throughout the greater part of March as a result of numerous ionosphere storms, the dates of occurrence of which were as follows:—March 1st to 8th inclusive; 13th to 23rd inclusive (but excluding 17th and 18th); and 28th to 31st inclusive. Those at the beginning of the month were of unexpected severity.

Sudden ionosphere disturbances of the "Dellinger" type occurred as under, these and other times given in this report being GMT on the 24-hour clock notation:—(A) March 1st at 1319; (B) March 3rd at 0825. The effects of (A) were widespread, but lasted for only about 20 minutes, whilst those of (B) were confined mainly to easterly and southerly routes, but continued for about one hour.

The increased intensity and frequency of ionosphere storms exhibited during March and, in particular, their occurrence at the middle of the month, with subsequent moderation during its fourth week (i.e., from 24th to 27th inclusive), were substantially in accordance with the prospects for March which were given in the issue of this Journal published on February 20th.

As is well known, North Atlantic routes are very susceptible to the effects of such storms, and some idea of the extent to which reception may be impaired thereby is afforded by comparing the "disturbance factor" for August, 1940 (a month of few disturbances), with that for March, 1941. This is shown graphically by the accompanying curves (a) and (b) respectively.



## Wireless World

### Short-wave Receiving Conditions—

It will be observed that even during the most favourable period of the day in March disturbance was greater than that which obtained during all but one hour of the day in August last. Inci-

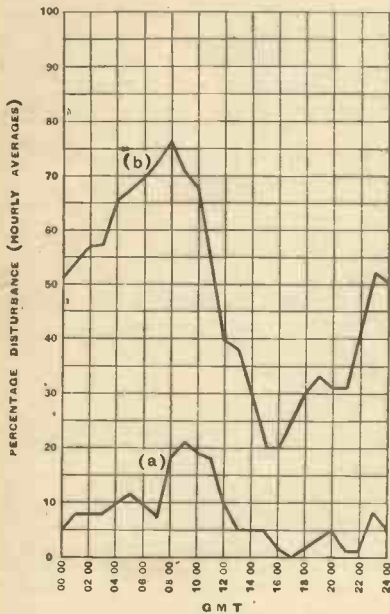

**A BAD MONTH.** The "disturbance factor" for the North Atlantic route during the month of March is shown by curve (b) in terms of hourly averages. Curve (a) represents a good month (August, 1940).

dentally, in regard to curve (b), readers of these reports may recollect that relatively poor conditions were predicted for the period around 0900 and conversely good reception for the period 1300 to 1900.\* The adverse conditions which prevailed on the North Atlantic route during the month under review proved to be more extensive than any experienced during the last eight years.

Fortunately, when signals along the direct route are rendered uncommercial, it is usually found practicable automatically to relay messages by way of an additional station, so situated that the signals to and from it traverse less-disturbed regions of the ionosphere.

Particulars of the broadcast bands which, it is considered, should prove most reliable during May under normal conditions of propagation at the times stated for five selected routes are given below; these may serve as a guide when considering the possibilities of reception from places not too remote from those specified.

Attention is drawn to the fact that

\* *The Wireless World*, March, 1941; p. 86.

a number of factors, for example, (a) transmitter power, (b) efficiency of aerials at both the transmitting and receiving end, and (c) ionosphere abnormalities, may often result in better reception being obtained on wavebands other than those quoted. Moreover, transmission on each of the stated bands may not be available.

**Cape Town:** Midt, 31 m; 0300, 31, 41 or 49 m; 0600, 19 or 25 m; 0900 and 1400, 16 m; 1800, 19 or 25 m; 2100, 25 or 31 m.

Signals are likely to be weak during the period from 1000 to 1300.

**Buenos Aires:** Midt, 25 or 31 m; 0300, 31, 41 or 49 m; 0600, 31 m; 1000, 16 or 19 m; 1400, 16 m; 1800, 16 or 19 m; 2100, 19 or 25 m.

This route usually presents difficulties at this season from about 0600 to 1100.

Echo may be prevalent around 1300 and 2000; there is a tendency, however, for these effects, particularly at the former time, to be less pronounced with the present decline in solar activity.

**Montreal:** Midt, 25 or 31 m; 0500, 31, 41 or 49 m; 1000, 19 or 25 m; 1400, 16 or 19 m; 1900, 19 m; 2200, 25 m.

Signal strength on this route, even under the most favourable conditions, is expected to be subnormal between 0600 and 1000. The best period is likely to be from 1200 to 2100.

**Cairo:** Midt, 31 or 41 m; 0400, 25 or 31 m; 0700, 25 m; 1100, 19 or 25 m; 1700, 25 m; 2100, 25 or 31 m.

Signals may be subject to weakness between 0900 and 1300.

**Bombay:** Midt, 31 m; 0500, 16 or 19 m; 0800, 1200 and 1500, 16 m; 1800, 16 or 19 m; 2100, 19, 25 or 31 m.

Signals may be weak between 0200 and 0500 and between 0800 and 1200.

At this season it is usual for ionosphere storms to decrease in intensity and, in the Northern Hemisphere, for atmospheric conditions to increase; the latter are generally most prevalent between midday and sunset on the shorter wavebands and between sunset and midnight on the longer wavebands.

At the time of writing this report there are indications that reception may be subnormal towards the end of the weeks ending May 7th, 14th and 21st.

## Morse Gramophone Records

IN view of the great stimulus which the war has given to the learning of the Morse Code, considerable interest will be aroused by a series of four gramophone records recently produced for the benefit of those studying without skilled assistance. They have been prepared with the co-operation of R.A.F. signallers, and, as might be expected, keying is beyond reproach. It is interesting to note that even in the earlier records which are at beginners' speed, the principle is adopted of not dragging out each letter so slowly that the whole of its rhythmic characteristic is lost. As explained in the text accompanying the records, the method of presenting the code and the order in which the various portions are taken for instructional purposes is based on the latest practice adopted by the three Services, while the procedure and special signs given are taken from the unified procedure of the Services.

In the textual key accompanying the records there is one small point of criticism which might with advantage be attended to in a later reprint. This is the printing of such symbols as **•••••** (end of message) as AR without any indication that they are invariably sent as one sign and not as separate letters; and this in spite of the care taken in the first record to explain this very fact.

The speed of transmission in the final records is approximately eighteen words per minute with a moderate background of jamming. The major part of the text consists of code and figure groups which cannot easily be memorised, and this, of course, is a great advantage. The complete set of four double-sided records with key costs 12s (tax 2s. 8d. extra) and is produced by The Columbia Graphophone Co., Hayes, Middlesex.

## The Wireless Industry

THE S.S. White Co. of Great Britain, Ltd., St. Pancras Way, London, N.W.1, have issued two supplements to the treatise on flexible remote controls mentioned in our March issue. They deal with applications to car radio and allied problems.

Holsun Batteries, Ltd., announce that their head office has been transferred to 137, Victoria Street, London, S.W.1. The telephone number remains as before, Victoria 1431/4.

We have received from British Insulated Cables, Ltd., Prescott, Lancs, a copy of Leaflet NSG6, dealing with "Pernax," a plastic tape for insulation and joint sealing, which is designed for use out of doors or in wet and corrosive atmospheres.

The head offices of Sloan Electrical Co., Ltd., have moved from Fetter Lane to 41, Kingsway London, W.C.2. A new East London depot has also been opened at 6, Albany Road, E.10.

# THE WORLD OF WIRELESS

## REVISION OF RESERVED OCCUPATIONS

### Its Effect Upon the Wireless Industry

IN following the general principle of imposing a much stricter application of the test as to whether or not work is essential to the war effort, the wireless industry will suffer to a certain extent with the introduction of the recently revised schedule of reserved occupations. It introduces a change of principle in reservation, namely, that account is taken not only of the occupation but of the actual work upon which a man is engaged.

In accordance with this plan, wireless engineers, fault finders, wireless repairers, mechanics and servicemen between the ages of 25 and 35 years will be reserved if they are engaged on work which is "protected" because of its importance to the war

effort. Men in these occupations over the age of 35 are reserved whether engaged on protected work or not. As in the past, men in these occupations will not be called on for service other than in a trade capacity.

There is virtually no change in the reservation ages of seagoing wireless operators, civil aviation operators, valve makers and those engaged on the maintenance of wireless transmitting and receiving equipment (including radio interference detection apparatus) in electrical communication and signalling systems.

Whereas loudspeaker cone makers were reserved from 30 there will in future be no reservation of men of military age in this occupation.

### VALVE SUPPLIES

THE valve situation is causing considerable concern among retailers. Whilst fully appreciating the needs of the Services, the National Council of the Wireless Retailers' Association recently voiced its feeling that more valves should be available to the public. It was pointed out that it is palpably necessary for the population to have receivers in working order not merely for the purpose of entertainment, but to ensure that official news is widely heard.

At a recent meeting of the Council of the National Association of Radio Retailers it was decided to make representations in the appropriate quarters for valves to be released for replacement purposes.

### BST

IN view of the Home Office decision to continue to use the designation British Summer Time for the period from May 4th to August 10th, when an additional hour will be added to the existing Summer Time, the use of the abbreviation BST in *The Wireless World* may cause some confusion.

As the May issue is current when both the old and the new summer time are in force, it should be noted that BST in this issue denotes time one hour only ahead of GMT.

America changes to Daylight Saving Time on April 27th. This will mean that transmissions from America will be received an hour earlier than scheduled during the period from that date until we change to the new Summer Time.

### B.B.C. BOARD

IT will be remembered that soon after the outbreak of war the B.B.C. Board of Governors was reduced from its peacetime number of seven to two; namely, Sir Allan Powell, who was appointed chairman in succession to Mr. R. C. Norman in March, 1939, and Mr. C. H. G. Millis, vice-chairman since 1937.

The Board has now been increased to six. The two serving members are continuing in office with the following new members: Sir Ian Fraser and Mr. J. J. Mallon, who were on the Board prior to its reduction, Mr. Arthur Mann, and Lady Violet Bonham Carter.

### FM SATURATION?

EDITORIAL comment in a recent issue of *Broadcasting* stated that saturation in FM is already evident in New York. The Federal Communications Commission, which has so far granted FM channels to the applicants in rotation, now finds that seven of the eleven channels available for "the nation's radio hub" have already been allocated, and that there are now many more applications than there are channels available.

Eleven frequency-modulated transmitters is the maximum permitted by the F.C.C. for metropolitan areas. It may, states the writer, be found technically possible to separate FM stations by only 100 kc/s instead of the present 200 kc/s. Some feel, however, that even this would be only a temporary measure.

## BROADCASTING FOR THE TROOPS

### Experiments Oversea

FOR some months past a scheme has been working satisfactorily for the entertainment of our Forces in Iceland by hiring an hour each day, except Saturday, from the Icelandic Broadcasting Company's long-wave station at Reykjavik. Iceland's 20-hour night in winter and the fact that the location of most of our troops is distant from the normal amenities of town life makes broadcasting an almost essential element of welfare. The cost of this hour is borne by the War Office Directorate of Welfare.

In order that the troops stationed in Iceland may receive the B.B.C. short-wave transmissions they are shortly to be equipped with 350 accumulator-operated short-wave receivers.

The experiment in Iceland has proved so satisfactory that a similar scheme is to be inaugurated for our Forces in the Middle East. For this purpose one of the stations of the Egyptian State Broadcasting Service will be used.

A study of the possibilities of instituting similar schemes for troops in other oversea theatres of operation is being undertaken.

### POSTAL SERVICING COURSE

FURTHER details are now available of the postal course in radio servicing, sponsored by the National Association of Radio Retailers, to which reference was made in last month's issue.

The first part of the course is devoted to an explanation, in a progressive manner, of the way in which each part of a receiving system operates. Throughout this part, which comprises ten lessons, it is shown how and where faults will give rise to various types of trouble. In the second part, the lessons deal with the various sections of a modern broadcast receiver. The function of each is explained, together with the correct method of servicing and checking for correct operation. The twentieth and concluding lesson deals with mechanical repair and assembly.

The course, which is available at an inclusive fee of 3 gns. to anyone in the wireless industry, is illustrated by circuits and diagrams, and each lesson is accompanied by a series of questions the answers to which are individually corrected and returned to the student.



## BRITISH STANDARDS IN WARTIME

### Two New Publications

THE British Standards Institution, which is helping Government departments in the preparation of War Emergency Specifications, as well as performing many other special tasks, still continues its normal work, and has recently issued two Specifications of general wireless interest.

Some time ago friction arose between water supply undertakings and electrical interests over the practice of earthing to water pipes. Conflicting views were apparently largely reconciled in 1938, when agreed regulations for earthing were issued. A British Standard Specification (B.S.951-1941) covering these regulations has now been produced. It is based on performance rather than on mechanical design of earthing clamps, etc., but certain mechanical features of construction are laid down. For instance, the earthing lead must not be connected to a screw used for tightening the clamp on the pipe.

The second Specification, B.S.415-1941, deals with safety requirements for "mains-operated apparatus for radio, acoustic and visual reproduction," and is a revision of an earlier specification already reviewed in our pages. A new section, dealing with the installation of apparatus, has been added.

The Specifications are obtainable from the British Standards Institution, 28, Victoria Street, London, S.W.1, at 2s. 3d. each, including postage.

### RECORDING TECHNIQUE

INSTEAD of the usual method of removing the swarf or thread from a wax recording during cutting by means of a rubber tube near the stylus, which is connected to a vacuum pump and sucks away all the shavings, a recording company in the U.S.A. has developed a blower system which directs a tiny blast of air across the surface of the disc just behind the cutting-head and so impels the thread of coating material to the centre of the disc.

This method is claimed to be an improvement on the vacuum system as the air-stream is removed from the proximity of the cutting stylus where it cannot produce air noise in high-quality recordings.

With direct-recording discs, the surface of which is less delicate than a wax, such devices as automatic brushes or thin rubber wiper-blades (known in America as "chip-chasers") are employed.

## DEFENCE OF LONDON

### Wireless Men Wanted

THE Commanding Officer of London District Signals (Royal Corps of Signals) asks us to draw attention to the fact that his unit needs wireless men—not necessarily fully trained—for operating and maintenance work. The age limits for enlistment (18 to 59 years) are exceptionally wide, and the conditions of service are such as to appeal especially to those living in London. One of the most important tasks of the unit is to maintain a wireless service between all military strategical points in its area as a safeguard against landline breakdowns through enemy action; the work is interesting and opportunities for promotion are good. Application should be made to St. John's Wood Barracks, St. John's Wood Road, London, N.W.8.

### R.C.A. REPORT

THE twenty-first annual report of the Radio Corporation of America shows a net profit of \$9,113,156, which is an increase of 13 per cent. In the review of the Corporation's activities for 1940 some interesting details are given. It is announced that a simplified model of the electron microscope is being built for use in educational, medical and industrial research laboratories. It is less than one-half the size of the original model, costs less than half as much and is plugged into an ordinary lighting socket.



THE "RADIO VEST," developed by R.C.A. for the use of the police, fire and other services, is a complete U-S-W transmitter-receiver.

## THE I.A.R.U.

IN announcing the affiliation of the Brazilian amateur radio society, Liga de Amadores Brasileiros de Radio Emissao, to the International Amateur Radio Union, Mr. K. B. Warner, the secretary of the Union, states that 37 countries are now members.

In Brazil there are about 1,000 amateur operators, all of whom belong to the L.A.B.R.E. Due to present international conditions amateurs in that country are not allowed to contact stations in foreign countries actively at war, so the emphasis is on domestic communication. Numerous groups of amateurs form weather-reporting nets and emergency communications reserves. The Brazilian amateurs' official organ is called QTC—"I have a message for you."

## FROM ALL QUARTERS

### B.B.C. News on Short Waves

THE transmission of news in English in the B.B.C.'s European and World Services takes place at the following times (BST), and, at the time of going to press, on the following short wavelengths. Those marked with an asterisk are used in the European Service.

0030	...	49.59*			
0100	...	31.32, 31.25, 25.53.			
0245	}	49.10, 31.32, 31.25, 25.53.			
0530					
0715	...	31.55, 31.32, 31.25, 25.53, 10.00.			
0900	...	49.59*, 41.49*, 31.55, 30.96*, 25.53, 19.82, 19.06, 10.00, 16.84.			
1200	...	31.25, 19.82, 19.06, 16.86, 16.84, 13.97, 13.92.			
1400	...	25.53, 19.82, 19.06, 16.86, 16.84, 13.97, 13.93, 13.92.			
1430	...	49.59*, 41.49*, 25.38*, 25.29*.			
1700	...	31.75, 25.53, 16.84, 13.93, 13.92.			
1900	...	41.96, 31.25, 25.53, 24.92, 19.82, 10.00.			
2145	...	31.25, 25.53, 25.38, 25.29, 10.82.			
2300	...	49.59*, 41.49*, 30.96*.			
2345	...	31.32, 31.25, 25.53.			

### M. Braillard

M. RAYMOND BRAILLARD, director of the Brussels wavelength checking station of the Union Internationale de Radio-diffusion, which was removed to Geneva when the Nazis invaded Belgium, has now given up this position which he has held for many years. Since January 1st he has been director of the technical services of the National Broadcasting Service in unoccupied France. It is rumoured that the U.I.R. checking station is to be reinstated in Brussels.

### Yugoslav Listeners

ACCORDING to the latest available figures there are 185,000 licensed listeners in Yugoslavia, which is approximately 1.9 per cent. of the population. A receiving licence costs 300 dinar (approx. 30s.).

### Brit. I.R.E. Incorporated with I.W.T.

At an extraordinary meeting of the Institute of Wireless Technology on March 22nd, the members unanimously

# Wireless World

## The World of Wireless—

agreed to the fusion of the I.W.T. with the British Institution of Radio Engineers. The combined bodies will be known as the British Institution of Radio Engineers Incorporated with the Institute of Wireless Technology, and will have its headquarters at Duke Street House, Duke Street, Grosvenor Square, London, W.1. Sir William Noble has been invited to be president of the joint body, the first meeting of which will be held on April 26th. Examinations have been arranged to take place on May 16th and 17th.

### Echoes

In the eleventh annual report of the Australian Radio Research Board some details are given of the observations on the ionosphere in the investigation of

which an automatic effective height-recorder covering the range of frequencies from 2 to 13 Mc/s in 2½ minutes was used. The Board's investigation of the ionosphere and atmospheric revealed the presence of reflected waves.

### Brazilian Short Waves

WHAT appears to be one of the largest short-wave stations in the Western Hemisphere is being erected by the R.C.A. Manufacturing Company for the Brazilian Government at Rio de Janeiro. The new 50-kW transmitter will be linked with five directional and three non-directional aerials. Two of the directional arrays will be beamed on Europe, two on the U.S. and one on Asia. The station is scheduled to be ready for operation by next January according to present arrangements.

### Training Operators

In order to train men for the Services and the Mercantile Marine the North British Wireless College of 21, West Maitland Street, Edinburgh, has equipped three main telegraphy rooms with 71 key points. Each point is fitted for duplex working. Verisimilitude to working conditions is given by introducing interference.

### B.B.C. Publicity

THE B.B.C. recently introduced an innovation by transmitting for the benefit of the European Continental Press a summary of the programmes in the Home, World and European Services for the following twenty-four or forty-eight hours. It is radiated at 14.45 BST on 373.1, 41.49, 25.38 and 25.29 metres.

## NEWS IN ENGLISH FROM ABROAD

### REGULAR SHORT-WAVE TRANSMISSIONS

Country : Station	Mc/s	Metres	Daily Bulletins (BST)	Country : Station	Mc/s	Metres	Daily Bulletins (BST)
<b>America</b>				<b>Manchukuo</b>			
WNBI (Bound Brook)	17.780	16.87	4.0†, 6.0.	MTCY (Hsinking)	11.775	25.48	8.0 a.m., 10.5.
WBOS (Millis)	9.570	31.35	11.45.	<b>Nova Scotia</b>			
WCAB (Philadelphia)	15.270	19.65	12.30 a.m., 7.45.	CHNX (Halifax)	6.130	48.94	10.45.
WCBX (Wayne)	9.650	31.09	9.55‡, 11.45‡.	<b>Newfoundland</b>			
WCBX	11.830	25.36	7.30‡.	VONG (St. John's)	5.970	50.25	11.15.
WCBX	17.830	16.83	2.0‡, 3.0, 4.0‡, 4.15‡, 5.0‡, 5.30‡.	<b>Sweden</b>			
WGEO (Schenectady)	9.530	31.48	8.30‡, 10.55‡.	SBO (Motala)	6.065	49.46	10.20.
WGEA (Schenectady)	15.330	19.57	1.0, 2.0‡, 6.0, 7.45.	<b>Thailand</b>			
WPIT (Pittsburgh)	15.210	19.72	6.0.	HSP5 (Bangkok)	11.715	25.61	12.45
WRUL (Boston)	11.790	25.45	8.15‡, 9.30‡.	HS6PJ	19.020	15.77	12.45
WRUL	15.350	19.55	8.15‡, 9.30‡.	<b>Turkey</b>			
<b>Australia</b>				<b>U.S.S.R. (Moscow)</b>			
VLQ (Sydney)	9.615	31.20	8.0 a.m., 8.0.	49-metre band	—	—	1.0 a.m., 7.30, 9.0, 11.0.
VLQ5	9.680	30.99	1.30, 4.30, 8.15, 10.30.	41 " " "	—	—	7.30, 9.0.
VLQ2	11.870	25.27	8.0 a.m., 2.40, 6.55.	31 " " "	—	—	5.0, 7.30, 9.0.
VLQ7	11.880	25.25	2.15, 8.0, 11.0.	25 " " "	—	—	12.0 noon, 5.0, 7.30.
VLQ8	17.800	16.85	7.0 a.m.	19 " " "	—	—	} 7.33 a.m., 12.0 noon.
VLQ8	17.800	16.85	7.0 a.m.	16 " " "	—	—	}
<b>China</b>				<b>Vatican City</b>			
XRVC (Chungking)	7.508	39.96	11.30 a.m., 12.10, 9.30, 10.30.	HVJ	6.190	48.47	8.15.
<b>Egypt</b>				<b>Yugoslavia</b>			
SUX (Cairo)	7.860	38.14	6.50, 10.10.	YUA (Belgrade)	6.100	49.18	10.25.
<b>Finland</b>				<b>LONG- AND MEDIUM-WAVE TRANSMISSIONS</b>			
OFD (Lahti)	9.500	31.58	12.15 a.m., 7.15, 10.15.	kc/s      Metres			
OFE	11.780	25.47	12.15 a.m., 8.40 a.m., 7.15, 10.15.	<b>Egypt</b>			
OIE	15.190	19.75	12.15 a.m., 7.15, 10.15.	Cairo	1,348	222.6	6.50, 10.10.
<b>French Equatorial Africa</b>				<b>Greece</b>			
Brazzaville	11.970	25.06	8.45.	Athens	601	490.2	8.45.
<b>Greece</b>				<b>Ireland</b>			
Athens	7.075	42.40	8.45.	Radio-Eireann	565	531	1.40, 6.45‡, 10.5‡, 10.10‡.
Athens	9.935	30.19	8.45.	<b>U.S.S.R.</b>			
<b>India</b>				Moscow 1	172	1,744	11.0.
VUD3 (Delhi)	9.590	31.28	1.30, 4.50.				
VUD4	11.830	25.36	9.0 a.m., 1.30, 4.50, 6.15.				
VUD3	15.290	19.62	9.0 a.m.				
<b>Iran</b>							
EQB (Teheran)	6.155	48.74	7.30.				
<b>Japan</b>							
JLG2 (Tokio)	9.500	31.57	10.30.				
JZI	9.535	31.46	6.0.				
JZJ	11.800	25.42	6.0.				

It should be noted that the times are one hour only ahead of GMT, and are p.m. unless otherwise stated. The times of the transmission of news in English in the B.B.C. Short-wave Service are given on the preceding page.

\* Saturdays only. § Saturdays excepted. † Sundays only. ‡ Sundays excepted.



# Economy in

# Receiver Maintenance

By "SERVICE"

IT is in the power of most service engineers to carry out quite a number of legitimate modifications to sets they are repairing which will help the National economy effort considerably. Some of them will be enforced by circumstances beyond our control, but wherever possible the aim should be to conserve material and to prevent the return of faulty material to the manufacturer whenever it is possible for the components to be repaired locally. Manufacturers are having a hard time in maintaining their service of spare parts and technical information due, not only to lack of parts, shortage of valves, etc., but also to severe depletion of staff.

Government work is making a greater and greater demand upon the manufacturing facilities of radio factories, and it will be left to service engineers who are outside the field of military activities because of medical or age considerations to carry on maintenance work to the best of their ability.

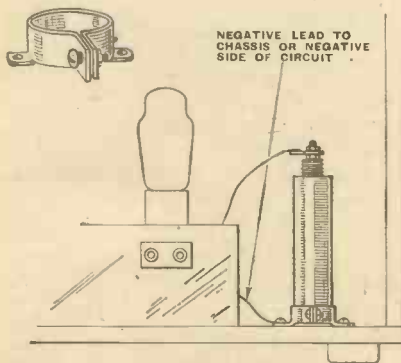

Fig. 1. Position for replacement condenser where there is space between chassis and side of cabinet. Inset is shown a type of clip for fixing tubular electrolytics in cases where one-hole fixing cannot be employed.

In normal circumstances it would generally be cheaper to replace a faulty coil than to repair the winding, but under present wartime conditions the fitting of a replacement coil, even if one were obtainable, is not always justified.

Transformers are another type of component which it is now desirable to have rewound, rather than that they should be scrapped and replaced.

There are many firms which are open to take on this specialised work, and faulty transformers of all types should be sent away for rewinding; in any case it is quite likely that the manufacturers will be able to fulfil orders for transformers for replacement.

Fig. 2. Alternative position for a replacement condenser.

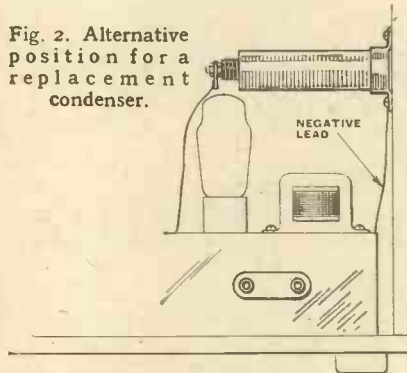

Multiple condenser blocks must not be returned just because one of the sections becomes faulty. The defective section should be isolated, and a new component of suitable value and type wired into the circuit in its place. Several manufacturers are advocating this policy themselves, and provide suitable clamps which enable single tubular condensers of the centre-hole fixing type to be fixed to the inside of the cabinet. With such a modification it must not be forgotten that a connection must be made not only from the positive terminal of the condenser to the HT positive point in the circuit, but there must also be provided a connection between the case of the condenser and the chassis, or negative part of the circuit.

## Lowered Standards

The effect which may be noticeable with this modification brings us to another important question concerning the standard demanded from a receiver under present difficult conditions. Fixing an external smoothing condenser with its long leads may slightly increase hum, but if there is no simple way of overcoming this trouble the conditions must be accepted by the owner of the receiver.

A similar position will undoubtedly be necessary concerning valves. Supplies of these important accessories are

Where the  
Service-man  
Can Help

bound to become very scarce and owners of receivers will have to tolerate loss of sensitivity by using valves far past the point in their lives at which they would normally be replaced. If RF or IF valves lose their emission to an extent which prevents full amplification on distant stations but enables the B.B.C. transmissions to be obtained well, the owner of the receiver must put up with this state of affairs and continue to use the valves until the very last amount of service has been obtained from them.

Quality of reproduction is a little more difficult to deal with and low-emission AF or output valves can destroy the enjoyment of listening to a good symphony concert, but where only slight loss of quality is noticed this should be tolerated, especially, as is so often the case, the transmissions themselves are hardly up to pre-war standard.

In many instances certain types of valves, especially the older ones, will be unobtainable but the service engineer who has retained his *Wireless World* valve data issue will be able to

Fig. 3. How a one-inch galvanised conduit saddle may be used to fix an external tubular condenser.

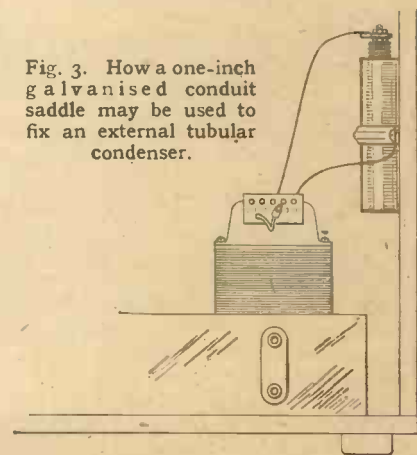

select suitable modern equivalents to use in place of them, even if it means changing the older type 5-pin valve

### Economy in Receiver Maintenance—

holder for a modern 7-pin type and altering the circuit. The wartime service engineer must learn to improvise as well as to economise.

Cabinet repairs will be a problem as many manufacturers are having seriously to curtail their woodwork departments due to the lack of timber, as will be appreciated from the appearance on the market of receivers with bakelite cabinets made by manufacturers who have always prided themselves on their cabinet woodwork. It is practically impossible to get cabinets replaced so that faulty ones have to be repaired, and if this can be done locally expense and delay and possible further damage in transit will be avoided.

Forethought in these matters shows an earnest interest in the National effort. We are digging for victory,

saving for victory and working for victory. The service engineer will be playing his part by economising for victory.

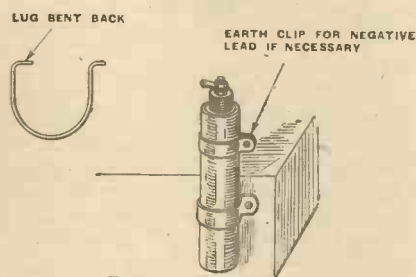

Fig. 4. Mounting a condenser on the chassis with the help of an improvised single-hole fixing clip (shown in inset). If the case is not at chassis potential it must be isolated by means of insulating paper or tape.

# LETTERS to the EDITOR

## *The Editor Does Not Necessarily Endorse the Opinions of His Correspondents*

### High and Low Frequency Loud-speakers

THE article in your April issue prompts me to air my views. Looking back over the last fifteen years one has seen the gradual straightening out of the response curves of amplifiers, input and output transformers, RF and detector stages of receivers, pick-ups and microphones, until all but the last two have become virtually straight lines. The microphone and pick-up even now approach the ideal. By comparison, the loudspeaker has stood still for the last ten years, and the revealing war of words between the advocates of horn, on the one hand, and baffle, on the other, has come and gone, leaving their respective speakers with an additional small cone apiece.

The article on page 108 rather gives the impression that the bill has been met by the use of composite diaphragms, where moderate sound outputs are concerned, and that banks of speakers plus frequency dividing networks are a solution to higher power-handling problems. I can believe the latter far more readily than the former. In any case, it is the moderate power case which concerns the great majority, and whilst it is a deplorable fact that this same majority is quite content with the quality which their ten- or fifteen-guinea radiograms provide, there are still many stalwarts who would give a great deal to get

the business end of their sound equipment out of the rut in which it seems to have lodged. My own careful and critical listening to very many commercial reproducers, my experiments with dozens of speakers having plain, compound and composite diaphragms, and finally talks which I have had with manufacturers in the camps of both horn and baffle, have brought me to the conclusion that the loudspeaker response curve is little, if any, nearer to being pulled out straight and kept there than it was in the days of Rice and Kellogg. Although it may be true that a straight-line characteristic is not the only criterion, the simple fact remains that a single cone will not deal effectively with all frequencies between the accepted 50 to 10,000 c/s. (let alone a wider range). Can we be satisfied that two cones meet the case? If two is only a partial solution why not three? In any case, why stop at three? The most successful diaphragm I ever made was a compound one having eight two-inch cones, and weighing no more than a single paper cone of the same combined surface area.

The radio-frequency side of our art is likely to be more and more obscured until civilisation has finished improving itself, so now is the opportunity to get to grips with this problem.

H. J. N. RIDDLE.

Wembley, Middlesex.

### Short-wave Conditions

WITH reference to the article under the heading of "Short-wave Receiving Conditions" in the January issue of *The Wireless World* just to hand, we can confirm the Dellinger fade-out for November 15 of last year.

At the time we were taking the B.B.C. News Service via GSI/V at 0830, and our log shows that the fade-out occurred precisely at 0835 GMT on all Northern signals. The signal which at 0830 gave us a noise level of -25 db. disappeared altogether in five minutes, but there was a slight reappearance of the GSV signal at 0850, and signals were normal on all bands before 0930.

R. MORRIS,

Engineer-in-Charge, Panorama Receiving Station, South African Broadcasting Corporation.

### The Future of Amateur Radio

I have read the recent articles and correspondence in your journal on the subject of the future of amateur radio and have also looked up the article in the *T. & R. Bulletin* of the R.S.G.B. referred to in your April editorial, and would like, if I may, to add some comments of my own, as one whose interest in amateur transmission—despite a G3 licence—extends back over fifteen years or so.

The main point at issue seems to be the question of the organisation of amateur transmission after this war, and in particular of how contact with the G.P.O. on the subject of amateur licences shall be established. In this connection your contributor "Navigator" suggests that "a committee, including some pre-war amateurs, be set up and should be given full powers to advise the G.P.O."

Now let us look at the facts. The R.S.G.B. at the outbreak of war included in its membership well over 80 per cent. of the fully licensed amateur transmitters in this country, and as such could justly claim to represent their interests. This fact was, and still is, fully recognised by the G.P.O., and is no doubt the reason why, on every matter affecting amateur licences, the R.S.G.B. has been, and is being, consulted by the Post Office. As your editorial points out, there will almost certainly be a big increase of interest in amateur radio transmission after the war, and, consequently, the need of a body to represent amateur transmitters as a whole will be greater than ever.

In the light of the facts mentioned above, what better organisation could there be for this purpose than the R.S.G.B., with its record of hard work



## Letters to the Editor—

on behalf of amateur interests—and hard work it has been, particularly at the international Telecommunications Conferences, where every effort has been made in the past by commercial interests and others to cripple or very gravely restrict amateur transmission. The fact that the war has not interfered with the steady growth in membership of the Society, particularly amongst members of the Forces, is obviously an added point in its favour.

This being so, it is difficult to see what could be gained from "Navigator's" rather airy suggestions of "a committee with full powers to advise," when such a body already exists and is functioning very efficiently. As "Navigator" is a member of the R.S.G.B. he must be aware of this, and one is led to the conclusion that the omission from his article of all reference to that body is merely an expression of some personal grievance.

That you, Sir, were in honour bound to support your contributor I have no doubt, but the suggestion in your April editorial of the R.S.G.B. losing the confidence of its members and the reference to "a sole exclusive heaven" must appear to most members of the Society as so much plain nonsense, and are particularly regrettable in a journal of the standing of *The Wireless World*, which rendered yeoman service to the R.S.G.B. and the amateur transmitting movement fifteen or twenty years ago. No one would wish to discredit the ideas of any contributor to your journal merely because they did not coincide with one's own or with R.S.G.B. views, but when a contributor makes a suggestion which, if carried out, would override completely the one organisation which has done so much for the amateur transmitter in this country, and which to my own knowledge has the support of its members as never before, despite the cessation of all amateur transmission, then it is time to point out to him the error of his ways.

E. H. JONES (G3CJ).

Bolton, Lancs.

I SHOULD like to offer my congratulations on the Editorial in the April issue of *The Wireless World*.

The remarks made cover quite adequately the very silly opinions expressed in the *T. & R. Bulletin*, and I hope that the R.S.G.B. will see the unrepresentative nature of the matter they saw fit to print.

Another point the R.S.G.B. seem, rather foolishly, to try continually to make, concerns new transmitters. There has been for some years a continual moan from the pages of the

*T. & R. Bulletin* of the inadequacy of the amateur bands and the increasing difficulties in operation. Yet, in spite of these objections, their policy seems to be to go out of their way to persuade anyone to become an R.S.G.B. member and get a transmitting licence. By all means encourage people who have a mild interest, but why try to make one's own and one's friends' experiments more difficult and less successful than they need be?

In conclusion I will wish *The Wireless World* continued success and the maintenance of a very sound judgment that has always correctly interpreted the feelings of the radio public.

W. CROSSLAND

(G5CI; Mem. R.S.G.B.).

Whitstable, Kent.

## Book Review

**The Meter at Work.** By John F. Rider. Pp. 152; 138 diagrams and illustrations. John F. Rider Publisher, Inc., 404, Fourth Avenue, New York City, U.S.A. Price (in U.S.A.) \$1.25.

THIS is a frankly elementary book evidently intended to meet that curiosity about measuring instruments that shows itself early and keenly in the careers of all normal students of radio. It provides a general survey of the principles of basic meters, and may well form a preliminary to their more detailed and mathematical study. Moving-coil, moving-iron, electrostatic, dynamometer, and other types are dealt with: composite measuring devices, such as valve-voltmeters, etc., incorporating basic meters, are rightly considered outside the scope of the book. What each basic type measures and how it does so is clearly explained; the differences between meters and their suitability for special sorts of measurements are discussed so that the reader should have no difficulty in choosing the correct meters for particular sorts of work; their mechanical construction is well described; illustrations greatly assist the text in all cases. Sufficient mathematical considerations are canvassed to enable the student to understand and design voltage multipliers and current shunts and to comprehend the action of rectifier instruments.

The construction of the book itself is interesting in that it is transversely divided into entirely separate upper and lower portions: the upper part contains all the illustrations, which may thus be found and studied without turning pages back and forth in the text to do so.—W. H. C.

## The "Fluxite Quins" at work



Ol's having a nightmare. "I'll bet,"  
Cried EE, "It's those pickles he ate."

But Ol heard in his dreams

"Give me FLUXITE!"—and screams  
From a frustrated radio set.

See that FLUXITE is always by you—in the house—garage—workshop—wherever speedy soldering is needed. Used for 30 years in Government works and by leading engineers and manufacturers. Of Ironmongers—in tins, 4d., 8d., 1/4 and 2/8.

Ask to see the FLUXITE SMALL-SPACE SOLDERING SET—compact but substantial—complete with full instructions, 7/6.

Write for Free Book on the art of "soft" soldering and ask for Leaflet on CASE-HARDENING STEEL and TEMPERING TOOLS with FLUXITE.

TO CYCLISTS! Your wheels will NOT keep round and true unless the spokes are tied with fine wire at the crossings AND SOLDERED. This makes a much stronger wheel. It's simple—with FLUXITE—but IMPORTANT.

## THE FLUXITE GUN

is always ready to put Fluxite on the soldering job instantly. A little pressure places the right quantity on the right spot and one charging lasts for ages. Price 1/6, or filled 2/6.

FLUXITE LTD.

(Dept. W.W.),  
BERMONDSEY  
STREET, S.E.1

ALL MECHANICS WILL HAVE

# FLUXITE

IT SIMPLIFIES ALL SOLDERING

# UNBIASED

## The Earliest Amateur

THERE seems to be quite a lot in *The Wireless World* these days about the future of amateur radio, and I cannot help getting the impression that both the Editor and his readers seem to think that to have possessed even a receiving installation thirty years ago, at the time when this journal was born, implies a sort of guarantee of venerable respectability. In fact, just as the majority of ordinary broadcast listeners seem to think that the science of wireless began in 1922 with the birth of the B.B.C., there are apparently quite a number of more enlightened folk who ought to know better—no names, no pack drill—who seem to think *amateur* wireless began in the early nineteen hundreds.

Perhaps it will interest these people to know that as far back as 1888 I possessed not only a wireless receiver but also a transmitter using open aerial technique at a time when most of the pseudo-ancient hams of 1900 onwards were solely concerned with "dummy" technique of a type not usually associated with wireless.

Probably many would be interested in a photograph of myself and apparatus at that time, but unfortunately in those pre-Leica days of wet plates and pinhole lenses I could not spare the



"Dummy" technique.

necessary number of hours required for a sitting. My receiver consisted of a simple Hertzian resonator, or in other words, a mere circle of wire with a tiny break for the spark gap. I obtained it, I recollect, by swapping a penknife and a quantity of toffee for it with a youthful member of the Hertz family who was at the same seat of learning with me in Germany.

A transmitter consisting, of course, of a simple spark coil was obtained in

## By FREE GRID

a similar manner from one of the young Ruhmkorfs, and I managed to send messages very successfully from one dormitory to another until I was discovered by a prowling master, and the apparatus confiscated. Barring Hertz himself, I think, therefore, that I may fairly claim to have been the earliest transmitter, and since he was obviously a professional, it leaves me without dispute as the earliest amateur.

## A Legal Loophole

IT has been said by somebody that no Act of Parliament has ever been drafted so skilfully that it was not possible to drive a coach and four through its provisions. Although I am no believer in wisecracks and smart sayings of this or any other kind, I must confess that I have never had any fault to find with this particular one, as it always seemed to me to be so manifestly true. For the most part, indeed, Acts of Parliament seem to be drafted by a congenial idiot, as the majority of them are so painfully easy to evade that there is little or no call for the exercise of ingenuity in so doing.

I must admit, however, that I thought I had found a great exception in the case of the Regulations forbidding car radio, which, as you know, prohibits the transport of a wireless set of any type in any sort of road vehicle. There seemed to be no loophole in the Regulations whatever, as even perambulators and wheelbarrows were, I found, on consulting the proper authorities, road vehicles within the meaning of the Act.

It is true that there appears to be nothing to stop the transport of wireless by a water vehicle, but discovery of this fact will be of precious little use to me until I take up my residence in Venice as part of the army of occupation after the war, and can persuade the local Romeos and Juliets to bring themselves up to date and at the same time to save themselves embarrassment by jettisoning the traditional singing gondolier in favour of a wireless set churning out appropriate hot music.



Car radio?

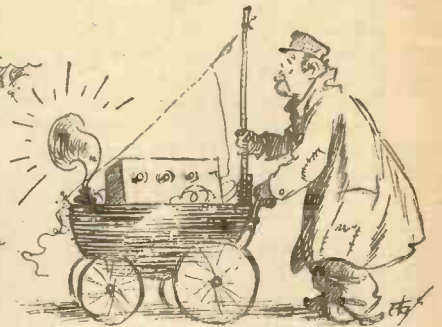

I was about to give up in despair and confess myself beaten by the law for the first time in my life when suddenly a solution of the problem came to me. Actually the idea came to me through my being called into consultation by the committee of a well-known hunt who are proposing to bring themselves up to date by going in for wholesale mechanisation, the old-fashioned horses being substituted by a fleet of light tanks.

As a result of this mechanisation project the horses were being disposed of for a mere song, and I was able to equip each member of my family with a thoroughbred at a knock-out price, thus solving the petrol rationing problem. It was, however, not until I had got the horses actually on the road that I realised that these animals were not vehicles within the meaning of the Act, and I kicked myself for not having thought of it before, or, to be more precise, one of my purchases did the kicking for me when I rather carelessly strayed into its zone of fire.

Since the horse is shod with metal there is no difficulty about an earth connection, as at least one leg of a horse is always in contact with the ground, except, as I subsequently found, when galloping, this little discovery incidentally solving an old controversy which raged in racing circles a few years ago. My greatest discovery in the case of horse radio was, however, the fact that by simply connecting the aerial lead to the bit the whole of the horse could be used as a capacity aerial, since excellent contact is made via the bit to its salivary glands and so to its whole body.

## F.G.T.

THE decision to continue to refer to BST when double summer time comes into force on May 4th is in the best traditions of official muddledom. Surely it would avoid all confusion, as well as being a fitting tribute to myself, the original suggester of it, if it were called F.G.T.



# Wide-Range Tuning Indicator

Improving the "Magic Eye"

**T**UNING indicators of the cathode-ray type are generally more sensitive to voltages well within the operating range than to extreme voltages. Thus, if such a device is adjusted to indicate resonance accurately on a carrier of average strength, it will not do so when the received carrier is abnormally strong or weak. A circuit arrangement for an indicator free from this defect, and possessing the same high sensitivity for both average and abnormal signals, has recently been devised by the R.C.A.

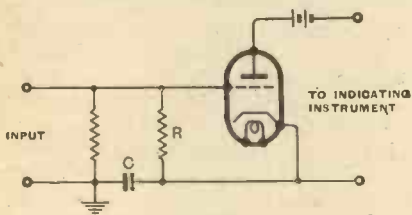

Fig. 1—How the intensity range of a cathode-ray tuning indicator may be widened by introducing a time-delay circuit.

laboratories, and is shown in very simple form in Fig. 1. The principle of operation, referring to this figure, is as follows:—

The voltage to be indicated is impressed upon the grid of the valve shown, and also, through a suitable time-delay network, upon its cathode. If the impressed voltage swings to an abnormal value, say, highly negative, the grid potential may swing outside the straight portion of the characteristic, and the valve may become effectively inoperative. However, after a time interval determined by the values of resistor R and condenser C, this abnormal potential difference between grid and cathode disappears. Thus, the valve comes under effective control again.

Fig. 2 illustrates the application of the principle to a radio receiver, in which a diode rectifier develops a signal across resistor R<sub>1</sub>. The time constant of the resistance-capacity circuit R<sub>2</sub>, C<sub>1</sub> feeding the cathode is appreciably greater than that of the circuit R<sub>3</sub>, C<sub>2</sub> feeding the grid, thus provid-

ing the necessary delay. The indicator valve may be a 6E5, which has a rod control electrode A between the cathode K and luminescent target T, this rod being supported by the anode and electrically connected to it, the tuning being indicated in the well-known way by contraction of the shadow thrown by the rod on the target. When a signal of abnormal strength is received the target shadow closes up and becomes unresponsive to adjustment of the tuning condenser; however, after the delay interval determined by the resistance and capacity values in the circuits R<sub>2</sub>, C<sub>1</sub> and R<sub>3</sub>, C<sub>2</sub> respectively, the valve returns to normal operating conditions and tuning can once more be performed by the visual indication of the shadow. As usually connected, the 6E5 is unresponsive to signals more negative than -8 volts on the grid; with the circuit of Fig. 2 it can be arranged to respond to swings as great as -220 volts.

Another possible arrangement comprises separate rectifiers for grid and cathode circuits. The same principle of differential delay is utilised, but preferably the long time-constant circuit connected with the cathode operates with a delay bias so that for sig-

Fig. 2.—The time-delay principle applied to a tuning indicator circuit.

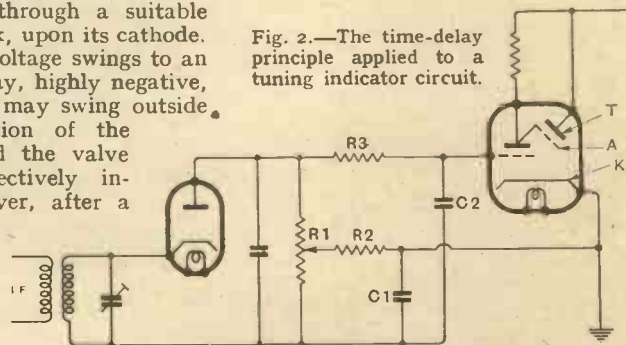

nals of less than a certain amplitude only one rectifier is operative.

The application of the arrangement described is not confined to the tuning indicator of a broadcast receiver. The "magic eye" is coming into increasing use as an inexpensive and robust indicator for measuring devices of various kinds, and in many of these a widening of the useful range would be a distinct advantage.

## VORTEXION 50w. AMPLIFIER CHASSIS

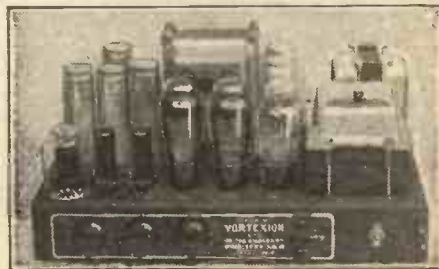

A pair of matched 6L6's with 10 per cent. negative feed-back is fitted in the output stage, and the separate HT supplies to the anode and screen have better than 4 per cent. regulation, while a separate rectifier provides bias. The 6L6's are driven by a 6F6 triode connected through a driver transformer incorporating feed-back. This is preceded by a 6N7, electronic mixing for pick-up and microphone. The additional 6F5 operating as first stage on microphone only is suitable for any microphone. A tone control is fitted, and the large eight-section output transformer is available in three types:—2-8-15-30 ohms; 4-15-30-60 ohms or 15-60-125-250 ohms. These output lines can be matched using all sections of windings and will deliver the full response (40-18,000 c/s) to the loud speakers with extremely low overall harmonic distortion.

CHASSIS with valves and plugs .....	£17 10 0
Goodmans P.A. Speakers in stock.	
Paper Machi Horn Speakers .....	£6 6 0
Moving Coil Microphones .....	£5 5 0
Chromium Microphone Stands from .....	15 0

Many hundreds already in use for  
A.R.P. & GOVERNMENT purposes

### 15w. AC & 12-VOLT DC AMPLIFIER



TYPE CP20

This small Portable Amplifier operating either from AC mains or 12-volt battery, was tested by "THE WIRELESS WORLD," October 1st, 1937, and has proved so popular that at Customers' demand it remains unaltered except that the output has been increased to 17.2 watts and the battery consumption lowered to 6 amperes. Read what "The Wireless World" said:—

"During tests an output of 14.7 watts was obtained without any trace of distortion so that the rating of 15 watts is quite justified. The measured response shows an upper limit of 15,000 c/s and a lower of 30 c/s. Its performance is exceptionally good. Another outstanding feature is its exceptionally low hum level when AC operated even without an earth connection. In order to obtain the maximum undistorted output, an input to the microphone jack of 0.037 volt was required. The two independent volume controls enable one to adjust the gain of the amplifier for the same power output from both sources, as well as superimpose one on the other, or fade out one and bring the other up to full volume. The secondary of the output transformer is tapped for loud speakers or line impedances of 4, 7.5 and 15 ohms." Prices:

AC and 12-volt CHASSIS with valves, etc. ....	£12 12 0
AC only CHASSIS with valves, etc. ....	£8 18 6

Gauge Case for either chassis, 12/6 extra.

Plus 20% War Increase.

Delivery: Prompt delivery on "Priority 1A" orders

Vortexion Ltd., 257, The Broadway,  
Wimbledon, S.W.19. 'Phone: LIBerty 2814

# RANDOM RADIATIONS

## Standard Sets ?

UNDER the Government's latest scheme for ensuring that every man, woman or factory is playing his, her or its full part in the national effort, it doesn't seem unlikely that there may have to be some closing of the ranks in the wireless industry. It's far more economical to keep the whole of one factory working whole-time than to produce the same output from a few shops of three or four factories, some of them, maybe, working only part-time. The wireless industry has been having, and is still having, a difficult time. Men have been called-up, girls have gone to the "Waafs," the "Wrens" or the "Afs," or into munition works. In some cases it has been necessary to call on wireless factories to concentrate their energies on making apparatus urgently required by the Fighting Forces rather than on receivers for the home. It would probably be an advantage to all concerned if a little carefully planned sorting out were done, some factories being earmarked entirely for Government work and others entirely for the supply of what Mr. and Mrs. Every-listener need. If this is done we shall almost certainly see some sets marketed "for the duration" as the joint product of two or three—or even more—well-known firms. We may even see the standard set.

## No Bad Idea

Whatever we may think of the standard set as a peacetime product (and there's a good deal to be said for it as such) we can't be in two minds about its utility and general desirability in wartime. After all, we can put up with the lack of frills in our wartime receivers: what is chiefly needed is something robust and reliable that will bring in entertainment and news from the home stations with reasonable volume and tolerable quality. What kind of set? Well, probably a 4-valve AC/DC superhet. (battery model as well, naturally) with an output of 2-3 watts. Simple and straightforward tuning—no press-buttons. The long-wave range is unnecessary in wartime, so the designer could concentrate on the medium and the long waves. If it were standardised by all, or even the majority of manufacturing firms, such a set could be turned out cheaply. The problems of replacements and repairs (they're becoming difficult

## By "DIALLIST"

now and are not likely to grow any easier while the war lasts) would to a large extent solve themselves. The replacement aspect applies particularly to valves.

## Valve Replacements

How many different types of even British valves there are to-day I don't know. In pre-war years I used to tot them up—and was generally pretty staggered by the increase over the total twelve months previously. Since the war began I've been too busily occupied to have much time for such things, but the number of present valve types, if not legion, is getting on that way. Certainly there are far more than are genuinely necessary. The authorities have had to do something to curtail the waste of effort called for by the production of such a galaxy, with the result that some kinds are now very difficult to obtain. The adoption of a standard receiver equipped with four standard valves would obviously do much to ease the position. Were they free to turn their energies, so far as these are concerned with civilian needs, mainly on to the production of four widely used types, valve-makers could supply all our requirements and still have ample

workers and machinery to deal with the demands of the fighting and other Services.

## Makeshifts

You may, by the way, find (or have found already, to your sorrow) that when certain valves in your receiver go the way that all valves eventually go, replacements are all but—if not entirely—unobtainable. When this occurs there are two alternatives. The first (which won't commend itself to you) is to raise despairing hands and to lament that the set will be of no further use till peace returns; the second (which will) is to discover which available valve can be pressed into service as a substitute for the late lamented. A careful study of *The Wireless World* valve list will often reveal that there is something else of another make whose characteristics are not so very different from those that you want. If they are so near as makes no matter the same, but belong to a valve with a different kind of base, the old socket can be removed and a new one to suit the substitute valve installed in its place. Should there be some important difference in one or other of the characteristics, certain alterations—probably of the minor kind—in the circuit may be needed in order to fit in with them. There are two pointers. The worn-out and irreplaceable valve must be of a very special kind used in a very special circuit if you can't find something

## BOOKS ON WIRELESS

issued in conjunction with "The Wireless World"

	Net Price	By Post
"FOUNDATIONS OF WIRELESS," by A. L. M. Sowerby, M.Sc. Second Edition Revised ...	5/-	5/6
"RADIO LABORATORY HANDBOOK," by M. G. Scroggie, B.Sc., A.M.I.E.E. (Second edition in preparation) ...	10/6	11/1
"WIRELESS SERVICING MANUAL," by W. T. Cocking, A.M.I.E.E. Sixth Edition ...	6/-	6/6
"HANDBOOK OF TECHNICAL INSTRUCTION FOR WIRELESS TELEGRAPHISTS," by H. M. Dowsett, M.I.E.E., F.Inst.P., M.Inst.R.E. Sixth Edition Revised ...	21/-	21/9
"WIRELESS DIRECTION FINDING," by R. Keen, B.Eng. Hons. Sheffield, A.M.I.E.E. Third Edition ...	25/-	25/9
"RADIO DATA CHARTS," by R. T. Beatty, M.A., B.E., D.Sc. Second Edition ...	4/6	4/11
"TELEVISION RECEIVING EQUIPMENT," by W. T. Cocking, A.M.I.E.E. ...	8/6	9/-
"RADIO INTERFERENCE SUPPRESSION," by Gordon W. Ingram, B.Sc. ...	5/-	5/4
"LEARNING MORSE." Fifth Edition ...	6d.	7½d.
"RADIO DESIGNER'S HANDBOOK," Edited by F. Langford Smith, B.Sc., B.E. (Reprint in preparation) ...	8/6	9/1
"THE WIRELESS WORLD" GREAT CIRCLE PROJECTION MAP ...	2/-	Post free

Obtainable from Leading Booksellers and Railway Bookstalls or by post (remittance with order) from

ILIFFE & SONS LTD., Dorset House, Stamford Street, London, S.E.1



COMMUNICATIONS DEPEND....



ON SMALL  
PARTS....

In countless instances quite intricate pieces of apparatus are wholly dependent on the proved reputation and reliability of their component parts.

All products from the House of Bulgin are pre-eminent for superior design and workmanship, and every article bearing our Trade Mark has to pass exacting and exhaustive tests during the course of its production.

That is why every manufacturer of national importance incorporates Bulgin Components.

*Let us send you*

Our 80 pp. Radio Service Manual fully illustrates 280 circuits and diagrams. 1/- post free. Over 25,000 copies sold.

*The Choice  
of Critics*

FOR  
SWITCHES

The best Radio and small Electrical Switches in the world. Every one is the finest of its class, and the best for any job. Snap-action, low and constant contact resistance, reliable performance for tens of thousands of operations: all these are permanent characteristics. Over 100 types to choose from.

ALWAYS DEPEND ON



REGISTERED • TRADE • MARK

A. F. Bulgin & Co. Ltd., By-Pass Road, Barking, Essex

Telephone: Rippleway 3474 (4 lines)

that will carry on with the job when comparatively trifling modifications have been made.

Worth Noting

Sometimes if the valve for which no spare can be obtained is of the "compound" type the circuit arrangement may be modified to enable the work to be done by two valves of simpler kinds. A complicated multi-electrode frequency-changer may be replaced, after the exercise of some ingenuity, by two separate valves acting as oscillator and first detector respectively. Similar expedients may enable single "portmanteau" valves to be replaced by pairs of similar type in other parts of the set. Again, one "stage" of a receiver—an RF stage, for instance—may be cut out altogether, should stern necessity dictate, and still leave the set perfectly capable of bringing in the Home or Forces programmes satisfactorily. There are heaps of ways in which the apparently insurmountable difficulty presented by the impossibility of obtaining valves of particular kinds may be surmounted. Keen wireless men will probably welcome opportunities of pitting their brains against such difficulties.



A Big Change

AS I write the U.S.A. medium-wave stations have just completed their sweeping wavelength change. As announced in last month's *Wireless World*, no fewer than 795 of them out of 883 were due to do so. The change is the result of a big "clearing up of the ether" on the other side of the Atlantic, where reception conditions had become in many places even worse than they were over here before the U.I.R. brought out its succession of wavelength plans. The problem in North America is a knotty one. Both the United States and Canada are huge countries with great sparsely populated tracts between big towns. High power and a large number of stations are needed if any but the most local of services is to be provided. And high-powered stations can often make themselves heard in no uncertain way at great distances. The South American countries, Mexico in particular, added to the difficulties of the problem. It is hoped, however, that the new scheme, with its provision for the use of directional aerials where necessary and for the limitation of the output power of certain stations between certain hours, will do a great deal towards improving reception.

# RECENT INVENTIONS

*A Monthly Selection of the More Interesting Radio Developments*

## WIRELESS NAVIGATION

THE figure shows a DF receiver particularly designed for "homing" on to a short-wave transmitter. The signals are received on two mutually perpendicular aerials A, A<sub>1</sub> and B, B<sub>1</sub> (which may be replaced by a pair of Adcock dipoles) with an additional "vertical" aerial V for sense-determination. The pick-up from the aerial B, B<sub>1</sub> is fed to the receiver R after being modulated at M with a low-frequency note which serves to distinguish say the fore-and-aft line from one at right-angles to it.

The pick-up from the aerial A, A<sub>1</sub> is periodically reversed before reaching the

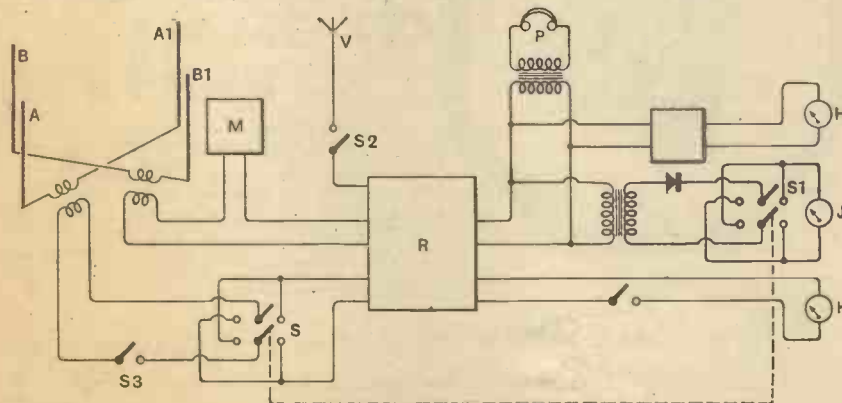

Aircraft homing system.

receiver by a switch S, which is worked synchronously with a switch S<sub>1</sub> between the receiver and an indicator J to show when the pilot is on or off his course. If the switches S and S<sub>1</sub> are operated in the rhythm of "complementary" morse signals, such as A and N, or I and T, an audible indication of any deviation to port or starboard will be heard in the headphones P or shown on the indicator H.

For "sense" determination, the aerial V is switched in at S<sub>2</sub> and the aerial A, A<sub>1</sub> switched out at S<sub>3</sub>, the "sense" of the direction then depending upon whether the indicator K shows a maximum or minimum reading. In practice the indicators J and K can be combined.

*Telefunken Ges. für drahtlose Telegraphie m.b.h. Convention date (Germany) 2nd February, 1938. No. 524653.*

## WIRED WIRELESS

WHEN relaying broadcast programmes over a wired system the volume control fitted to each subscriber's instrument should (a) give equal quality at all settings, (b) take energy from the distributing network in proportion to the volume produced, (c) be safeguarded against an accidental short-circuit of the loud speaker.

All these factors are taken into con-

sideration by using, as a volume control, the tapped secondary of a transformer coupling, the primary winding of which is of high ohmic resistance and presents the same impedance to the line—in the event of a short-circuit on the subscriber's side—as it does when the volume control is normally set for maximum volume. The inductance of the primary is made large and its self-capacity small, so as to give a substantially linear frequency response over the band of signals to be transmitted.

*N. V. Philips Gloeilampenfabrieken. Convention date (Netherlands), February 25th, 1939. No. 526087.*

from the dot signals) without affecting the negative pulses produced by the dash signals. The indicator is thus balanced so as to give equal deflections for equal deviations off-course either to port or starboard.

*Marconi's Wireless Telegraph Co., Ltd., and C. S. Cockerell. Application date, February 8th, 1939. No. 526412.*

## SHORT-WAVE AERIALS

THE top of the supporting mast of a television or other short-wave aerial is fitted with a metal cap which is bored to take a cross-bar so that the latter rests on the top of the mast. The cross-bar is anchored in position by bolts so that it can be readily dismantled for packing and transport. The usual dipole is mounted at one end of the cross-bar and a reflector at the other.

*Belling and Lee, Ltd., and F. R. W. Stafford. Application date, March 21st, 1938. No. 526587.*

## CATHODE-RAY TUBES

THE electrostatic deflecting plates of a cathode-ray tube are usually arranged in two pairs, which are set at right-angles to each other, and one behind the other, along the length of the electron stream. This makes the length of the tube greater than it otherwise need be, and also presents certain other disadvantages.

Accordingly it is now proposed to combine the four plates into a single unit in the shape of an open-ended box B, which occupies less space longitudinally, and also ensures that both pairs of plates act at the same point along the length of the stream. This, in turn, helps to reduce the width of the stream, and serves to maintain equal deflection sensitivity.

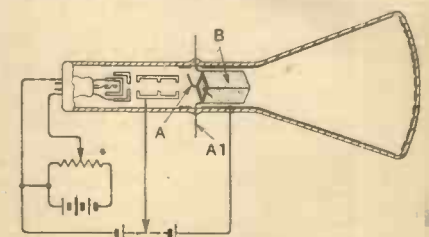

C.-R. tube with combined deflecting plates.

The sides of the box are made of a semi-conducting material, such as a ceramic base impregnated with graphite. A conducting strip is inset along each corner of the box, to which the deflecting voltages are applied at A and A<sub>1</sub>. The arrangement is stated to prevent "fringing," or de-focusing of the electron stream.

*Marconi's Wireless Telegraph Co., Ltd. (communicated by Radio Corporation of America). Application date 10th February, 1939. No. 525000.*

## STEERING BY WIRELESS

THE invention relates to the type of DF gear which enables an aircraft either to "home" on to a distant transmitter, or else to fly down the centre line of two overlapping radio beams by distinguishing between two sets of complementary signals, such as dots and dashes. In practice, it is found that, particularly when automatic volume control is used, the receiver tends to respond more strongly to the dots than to the dashes, and thus gives an off-course indication which is more pronounced to one side than the other. The reason for this unbalanced response is due in part to the different lengths, i.e., time-duration, of the two signals, and in part to the curvature of the valve characteristic.

To offset it, the receiver is provided with a shunt circuit, including a crystal or similar device, which is arranged so as to attenuate the positive pulses (derived

The British abstracts published here are prepared with the permission of the Controller of H.M. Stationery Office, from specifications obtainable at the Patent Office, 25, Southampton Buildings London, W.C.2, price 1/- each.



# ELECTRADIX RADIOS

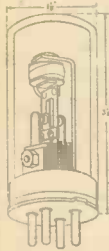

### L.T. Battery-operated Home-made VIBRATOR KITS

To obtain H.T. successfully. Supersede H.T. Batteries. The Vibrator converts D.C. to A.C. by vibrating uniformly. Any voltage up to 100 watts obtained by transformers and rectified for radio H.T.

American Vibrators totally enclosed, slightly dented covers. 4-pin non-sync. Low price Post free **12/-**



**CHARGE METERS.** Weston Model 354. Central zero 1 to 15 amps., pol. mag. dead beat. Flush panel, 2½ in. dial. **9/6**

### AUTOMATIC CIRCUIT BREAKERS

**SINGLE POLE, HEAVY IRON CASE 250/400 Volts**  
Illustration shows S.P. with cover removed

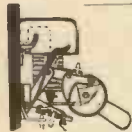

Rating	Type	Price
6 amps.	S 11/1G	11/6
6 "	S 11/1Z*	13/6
10 "	S 11/1G	16/-
15 "	S 11/1G	18/-

### 4in. x 5in. DOUBLE POLE, IRON CASED

Rating	Type	Price	Rating	Type	Price
1 amp.	S 11/2Z*	18/6	5 amps.	S 11/2Z*	25/6
1½ "	S 11/2Z*	19/-	6 "	S 11/2Z*	26/-
2 "	S 11/2Z*	20/-	6 "	S 11/2	23/-
2½ "	S 11/2Z*	21/-	10 "	S 11/2Z*	32/-
3 "	S 11/2Z*	22/-	10 "	S 11/2	30/-
4 "	S 11/2	22/-	12 "	S 11/2Z*	36/-
4 "	S 11/2Z*	25/-	15 "	S 11/2Z	34/-

### TRIPLE POLE, 3 TRIPS Light Iron Case 300/500 Volt

Rating	Type	Price
300 m.a.	S 11/3Z*	25/-
3 amps.	S 11/3	21/-
3 "	S 11/3Z*	24/-
4 "	S 11/3	21/-
6 "	S 11/3	32/-
10 "	S 11/3	38/-
15 "	S 11/3Z*	45/-

### TRIPLE POLE, 3 TRIPS Heavy Iron Case 300/500 Volt

Rating	Type	Price
500 m.a.	S 11/3Z*	26/-
800 "	S 11/3Z*	27/-
1 amp.	S 11/3Z*	24/-
2 "	S 11/3Z	22/-
2 "	S 11/3Z*	26/-
3 "	S 11/3Z*	28/-
4 "	S 11/3	23/-
4 "	S 11/3Z*	30/-
4 "	S 11/3Z*	30/-
6 "	S 11/3	36/-

### 2-AMP. THERMO TIME-LAG CIRCUIT BREAKERS

#### A SPECIAL DESIGN IN AUTO-SWITCHES

with time-lag, tripping on 2 to 3 amps. Safety thermo switch with long-break auto overload trip. For back of panel with front indicating knob, compact, 4in. x 2in. x ½ in. deep. Any voltage up to 1,000 v. (as illus.)

Worth a Guinea. Only **5/6**

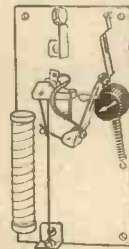

#### THE ROLLS-ROYCE OF BUZZERS

is the Cambridge-Townsend. Tiny and Shrill. Perfect for Wavemeters, ideal for signals. High note model "T." Diaphragm blade. Platinum Contacts. The smallest Buzzer possible. Price **10/-**



### INDEPENDENT POWER

300 watt Petrol Electric Set, 100 volts, 50/60 cycles, 3 amps. and 30 volts 10 amps. D.C. Portable, lightweight, with switchboard **£32**

### PETROL ELECTRIC GENERATING SETS For Lighting and Charging

Half h.p. DIRECT COUPLED, 150 watts D.C., 1,300 r.p.m., 2-stroke water-cooled 1-cyl. engine, magneto ignition. On bedplate with 30 volts 5 amps. Dynamo, **£13 75** Larger Size ½kW. Petrol Electric Sets, 500 watts, 2-stroke water-cooled 17 h.p. 1-cyl. engine on bedplate, direct coupled to 50/70 volts 10 amps. D.C. dynamo, magneto ignition **£17 10s.**

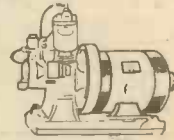

### ANOTHER RELAY FOR RADIO WORK

A 2 m.a. Table Relay. Compact vertical type, enclosed. Screened 500 or 2,000 ohm coils. Platinum contacts. Single pole change over on 2 m.a. ½ amp. contacts. Wood base. Metal Case. Size 2½ in. diam., 3½ in. high. Price only **10/-**

### REDUCTION GEARED A.C. MICRO MOTORS

Final shaft speed 60 r.p.m. Reversible, with 2-pole make switch. Squirrel cage rotor self-starting with dog clutch. For L.T. 12 to 25 volts or on mains with lamp res. Made for radio tuning drive, useful for models, record chart drums, time switching and many other purposes. High torque. Synchronous and precision made, 25/-. Precision made and new, 7/6.

### SPEAKER BARGAINS

**MOVING COIL SPEAKERS.** Mains energised, 6in. to 9in. All good makers, 6in. cone, 7/6. Few with damaged cones, 5/-. B.T.H. & Celestion O.K. 12/6. Few damaged cones 7/-.

**A.C. MAINS SPEAKERS.** Jensen with rectifier for 230 volts, 7in. cone and transformer - **25/-**

### PERMANENT MAGNET SPEAKERS

for extensions. Various makes and sizes as above, 18/6. Few with broken cones, 10/-. Brand new P.M. Speakers, G.E.C. and Rola - **25/-**

**BATTERY ENERGISED M.C. SPEAKERS,** Kolster-Brandes 4 to 6 volt, 8in. cone - **8/6**  
A few Reed Cone Speakers - **7/-**



### BATTERY CHARGERS

#### "NITNDAY" Metal Rectifiers—Steel Chassis

Model N/A 2½, Radio Home Charger. To charge 2 volts ½ amp.  
Model N/A 6½, Trickle Charger. To charge 6 volts ½ amp.  
Model N/B 6/1, Car Charger. To charge 6 volts 1 amp.  
Model N/B 6/1½, Car Charger. To charge 6 volts 1½ amps.  
Model N/C 6/2, Car Charger. To charge 6 volts 2 amps.  
Model N/D 12/1, H.M. Car Charger. To charge 12 volts 1 amp.  
Model N/D 12/2, N.K. Car Charger. To charge 12 volts 2 amps.  
Model N/E 2, Doubler. Car Charger. To charge 6 volts and 12 volts 2 amps.

ALL MODELS FOR A.C. 200/250 VOLTS INPUT.

**5/- EMERGENCY PARCELS,** useful stand-by electrical and radio repair material and apparatus, 10 lbs. for 7/-, or 7 lbs. 5/-.



# ELECTRADIX RADIOS

**WE ARE STILL AT —> 218, UPPER THAMES STREET, LONDON, E.C.4**

Telephone: Central 4611.

Stamped envelope must be enclosed for replies to enquiries

**CLASSIFIED ADVERTISEMENTS.** The charge is 6/- for each paragraph of 2 lines or less, and 3/- for every additional line or part thereof, average 7 words to a line. Each paragraph is charged separately.  
**ADVERTISEMENTS** for the June issue are accepted up to First Post on Thursday, May 8th, at the Head Office, Dorset House, Stamford Street, London, S.E.1. or one day earlier at provincial Offices.

THE PROPRIETORS retain the right to refuse or withdraw advertisements at their discretion. They are not responsible for clerical or printers' errors, although every care is taken to avoid mistakes. Cheques and postal orders should be made payable to Iliffe & Sons Ltd. and crossed. Notes are legal tender and cannot be traced if lost in transit.

ADVERTISERS may have letters, other than circulars, addressed to numbers at this office: The Words Box 000, c/o "WIRELESS WORLD" must be paid for and a further 1/- added for registration and forwarding replies.  
**DEPOSIT SYSTEM.** Full particulars upon application to the Deposit Dept., "Wireless World," Dorset House, Stamford Street, London, S.E.1.

**NEW RECEIVERS AND AMPLIFIERS**  
**McCLURE** Type ACF4 4-waveband Feeder Unit, complete with valves and magic eye, absolutely new and unused, latest model; £9.-21. Crosslands Av. Southall. [9538]

**HAVE Your Amplifier or Receiver Built to Your Specification;** high fidelity equipment a speciality. Estimates and advice free.—S.A.R. Supplies, 293, Norwood Rd., S.E.24. [9500]

**HEIGHTMANS V.H.F. Superhet Receiver,** valves and coils, constructed with the best materials, £10.—Hallierafter Skyriider Defiant, practically unused, £21.—Cosh (2DDD), Mill Rd., Angmering, Sussex. [9537]

**LIMITED Number of Wireless World Push-pull Quality Amplifiers Available.** Amplifiers with larger outputs and 12-volt battery models to special order.—Camborne Radio Co., Treloarwren St., Camborne, Cornwall. [9540]

**£15/10 Only, usual price £22.—Wireless World 2 R.F. Receiver,** with push-pull quality amplifier, chassis, 10 valves, including tone control stage, 8 watts triode output, ideal for quality reproduction from radio and gramophone; limited number.—Bakers Selhurst Radio, 75, Sussex Rd., South Croydon. [9519]

**RECEIVERS & AMPLIFIERS—SECONDHAND, ETC.**  
**HALLICRAFTERS Sky Champion;** £18; perfect condition.—50, Harlestone Rd., Northampton. [9516]

**NATIONAL HRO Senior, serial No. H9,** complete with speaker, power unit 230v. and coil units 10 to 1,700 metres, in rack mounting, black crackle finish, in perfect order and condition; buyer to collect, will not send by rail; price £65 net.—Lavin, Old House, Sonning, Reading. [9512]

**Wanted**  
**COMMUNICATION Receiver,** all-wave type preferred.—11, Parkfield Rd., Didsbury, Manchester, 20. [9533]

**COMMUNICATION Receiver,** in good condition; also Voigt speaker.—Box 2570, c/o The Wireless World. [9493]

**WANTED.—Communication receiver—Hitchings,** 58, Broadfields Av., Edgware, Middlesex. [9526]

**WANTED, good Communications Receiver;** cash; full particulars. "Phone number.—Davies, 1, Jeremiah St., London, E.14. [9541]

**WANTED, "Howard 430" receiver;** exchange six R.C.A. 954 Acorns and Standard McElroy Bug. all new.—Box 2574, c/o The Wireless World. [9509]

**COMMUNICATION Receiver, National HRO, 100A,** 100X, 100XA, RME, or similar; reasonable for cash.—Green, 3, Hobmoor Rd., Birmingham, 10. [9521]

**HIGH Class Chassis or auto change radiograms** wanted for spot cash. High price paid. Midwest, Scott, H.M.V., R.G.D., etc.—27, Worcester St., Wolverhampton. [9507]

**W.W. Pre-tuned Quality Receiver Only, 250v. A.C.** induction gramophone motor, tone-arm for E.M.G. head, Goodman's Auditorium speaker.—Box 2569, c/o The Wireless World. [9480]

**NATIONAL One-Ten Receiver, complete valves,** power supply, and instruction manual; state if receiver needs any servicing; quote price.—Box 2577, c/o The Wireless World. [9517]

**NEW LOUDSPEAKERS**

**BAKERS Brand New Surplus Speaker Bargains.**

**EVERY Music Lover Interested in Realistic Reproduction** should write for free descriptive leaflet now.

**£5/10;** usual price £10.—Brand new permanent magnet infinite baffle speaker, complete with beautifully finished cabinet in polished walnut.

**£2/10;** usual price £5.—Brand new super quality triple cone speaker, permanent magnet model; exceptional bargain; limited number.

**SECURE One of These Exceptional Bargains Now.**

**BAKERS Triple Cone Conversions Will Immensely Improve Reproduction of Your Present Speaker.** ("For a few shillings you have converted a speaker scheduled for the scrap heap into one worth pounds.—W. E. Darby, Grad.I.E.E.") Write for details.

**BAKERS SELHURST RADIO, 75, Sussex Rd., Sth. Croydon.** [9423]

**Wanted**

**G12 Rola, "Magnavox 66," or Hartley-Turner Duode speaker, P.M. or energised,** about 1,250 ohms.—Bowers, 34, Park St., Bath. [9534]

**DYNAMOS, MOTORS, ETC.**

**ALL Types of Rotary Converters, electric motors,** battery chargers, petrol-electric generator sets, etc., in stock, new and second-hand.

**WARD, 46, Farringdon St., London, E.C.4. Tel.: Holborn 9703.** [0518]

**Wanted**

**E.D.C.C. Car Alternator, 500-600 A.C. watts;** cash waiting.—Malden 2849. [9525]

# ARMSTRONG

## URGENT

In the April issue of "Wireless World" we appealed to our old customers with Armstrong chassis not in active use to sell them to us to enable the various components to be used to service other Armstrong chassis whose owners are in urgent need of them. We still require more chassis and will give a very good price if they are offered to us.

The Models particularly required are AW125PP, SS10, AW93PP, 3N8P/T, 3NWT, AW38, AW59/T, RF73, RF94, AW104PP, AW3PB, 3WT/PB. These models vary in age up to 4 years, but a few older chassis will be considered. It is not necessary for them to be in working order but it is essential for the majority of the mechanical parts to be in good order, so that they can be made use of for service work.

### ARMSTRONG

**Heavy Duty Speaker Transformers.** These high grade transformers are ideal for operating quality speakers or improving the frequency response of speakers fitted with small economically priced transformers. The windings are layer wound and interleaved. The following matchings can be supplied from stock:—

Primary 8,000 ohms centre tapped, for two Triodes in Push-pull. Secondaries to match 7, 8, 9, and 15 ohm speech coils.

Primary 4,000 ohms for single Triode output with secondaries to match 7, 8, 9, and 15 ohm speech coils.

Primary 7,000 ohms for single Pentode output with secondaries to match 7, 8, 9, and 15 ohm speech coils.

Price 17/6 plus postage.

Providing materials are available special matchings can be supplied. Kindly let us know your requirements.

**ARMSTRONG Heavy Duty Field Replacement Chokes.** 800-1,000 ohms resistance, capable of handling 150 m/amps. A very efficient and well made choke. Price 15/6 plus postage.

### ARMSTRONG CO.

have a limited number of high quality speakers at very economical prices, for example:—

11in. Heavy duty M.C. speaker, capable of handling a large output if so desired, fitted with free moving cone and very heavy field. D.C. resistance of field 800-1,000 ohms. Voice coil impedance 7 ohms. Price £3 3s. 0d

We recommend these speakers as particularly suitable for working with any of our Radio chassis and audio frequency amplifiers designed to give high quality output.

Armstrong Co. have various other speakers available, including Goodman's. Kindly send your requirements.

**ARMSTRONG MANUFACTURING CO.**  
 WARLTERS ROAD, HOLLOWAY, LONDON, N.7.  
 Phone: NORTH 3213.

# RELAYS

for A.C. and D.C.



High Sensitive Relay H.S.

**SILENT & RELIABLE**  
 2 VA coil consumption, from 2-600 volts, tested to 2,000 volts. Unmounted and in cast iron casing. Also Time Lag Relays, High Sensitive Relays, Synchronous Process Timers and Complete Control Plants.

Apply for leaflet SPN/WW

## LONDEX LTD.

Electrical Remote Control Engineer:

and Manufacturers  
 Anerley Works, 207, Anerley Road, London, S.E.20.  
 Tel.: SYDENHAM 6258/6259.

**NEW MAINS EQUIPMENT**

**VORTEXION Mains Transformers, chokes, etc.,** are supplied to G.P.O., B.B.C., L.P.T.B.; why not you?

**425** -0-425v. 120-160 m.a., 4v. 5-10a., 4v. 2.5a., 4v. 1-2a., 4v. 1-2a.; £1/12.

**500** -0-500 150 m.a., 4v. 4a., 4v. 2.5a., 4v. 2a., 4v. 2a., 4v. 2a.; £1/15.

**400** -0-400 or 450-0-450v.; same price.

**500** -0-500v. 120 m.a., 4v. 4a., 4v. 2.5a., 4v. 1-2a., 4v. 1-2a.; £1/8.

**400** -0-400v. or 450-0-450v.; same price.

**350** -0-350v. 120 m.a., 4v. 4a., 4v. 2.5a., 4v. 1-2a.; £1/1.

**350** -0-350v. 120 m.a., 4v. 4a., 4v. 2.5a., 4v. 1-2a., 4v. 6a.; £1/5.

**350** -0-350v. 75 m.a., 4v. 2-4a., 4v. 1-2a.; 18/-.

**250** -0-250v. 60 m.a., 4v. 2-4a., 4v. 1-2a.; 15/-.

**AUTO Transformers.**

**100** -120v. to 200-240v. 60 watts, 11/-; 100-120v. to 200-240v. 120 watts, 14/6; 100-120v. to 200-240v. 200 watts, £1/1; 100-120v. to 200-240v. 300 watts, £1/17/6; 100-120v. to 200-240v. 500 watts, £2/7/6.

**CHOKES.**

**30h.** 60 m.a. 400 ohms, 7/6; 7-13h. 120 m.a. 215 ohms, 12/6; 30h, 150 m.a., 200 ohms, 15/-; 25h. 150 m.a., 50 ohms. £1/1.

**OUTPUT Transformers.**

**4-10-WATT W.W. Q.A. Type,** £1/1; 20-watt P.A. model, £1/10; 40-watt for 6L6s, in negative feedback, £3/10.

**DRIVER Transformers.—For any Class B valves;** £1/10.

**WAR Increase on the Above Models 20%.**

**ALL Models Finished in Aluminium Die Cast A Shroudings Only;** primaries screened and tapped 200-250v. and centre tapped filaments.

**ANY Model Can be Fitted with 5v. or 6.3v. Filaments** if Required, provided that the wattage does not exceed that of the standard model.

**VORTEXION, Ltd., 257, The Broadway, Wimbledon, London, S.W.19. "Phone: Lib. 2814.** [9514]

**Wanted**

**MAINS Transformer as Used in "W.W." New Mono-dial Super, 1933;** also two PX4s.—Jennings, "Chartleigh," Oxted. [9523]

**PUBLIC ADDRESS**

**VORTEXION P.A. Equipment.**

**LIMITED, but unequalled.**

**WE Invite You to a Demonstration.**

**ALL P.A. Accessories in Stock;** trade supplied.

**SEE Our Display Advertisement on Page 143 (Edit.).**

**VORTEXION, Ltd., 257, The Broadway, Wimbledon, S.W.19. "Phone: Lib. 2814.** [9515]

**LET Us Estimate for Your P.A. Requirements;** wide experience in office, factory, dance-band and air-raid alarm systems, etc.; estimates and advice free. Competitive prices.—S.A.R. Supplies, 293, Norwood Rd., S.E.24. [9501]

**SHORT-WAVE EQUIPMENT**

**G5NI for Short Wave Equipment;** largest stocks in the country; communication receivers; National agents; American and British Valves, etc. See advertisement on page 2.—44, Holloway Head, Birmingham. [0531]

**CABINETS**

**A CABINET for Every Radio Purpose.**

**SURPLUS Cabinets (Undrilled) from Noted Make.**

**WE Have Hundreds in Stock (no Catalogues);** send measurements of chassis, etc., and say what kind of cabinet required; stamp for reply.

**INSPECTION Invited.**

**H. L. SMITH and Co., Ltd., 289, Edgware Rd., W.2. Tel.: Pad. 5891.** [9331]

**COMPONENTS—SECONDHAND, SURPLUS, ETC.**  
**SOUTHERN RADIO'S Wireless Bargains.**

**ALL Goods Previously Advertised Still Available.**

**SOUTHERN RADIO, 46, Lisle St., London, W.C.2. Gerrard 6653.** [9238]



**G. A. RYALL, "Arnehurst,"** Marsh Lane, Taplow, Bucks (late Ryalls Radio of London), offers radio goods, all new, unless otherwise stated. Post free.

**AMPLIFIER Chassis Complete,** ex the Pathoscope cine outfit, contains the two mains transformers as below; two H. units 8 m.f. 500v. Mansbridge 2x1 m.f., pair low voltage cathode condensers, group board with resistances as below, toggle switch, F.C.C. 0.01, two Erie resistances, 5-pin socket for speaker, fully wired, with mains leads and double adaptor, flat pancake-type chassis (SG as LF valve, pentode output, rectifier), gramophone input socket, three valve-holders, less valves; 18/6 the lot, carriage paid; chassis may be had without speaker if desired. See below.

**MAINS Transformers,** made by Standard Telephones for Pathe amplifier, input 110-250v. A.C., outputs 350-0-350v. 120 ma., 4v. 2 1/2 amp., 4v. 4-5a., special heavy primary, used as 250v. Auto trans. for other items below; can be used as 300v. auto transformer, drop through type, size 5 1/4 x 4 1/2 x 2 1/2 in. deep; 10/9 each, used, as new.

**A.C. Induction Motors,** fitted with fan cooling, 1,500 revs, one-tenth horse power, 110v., for use with above transformer, supplied 8 m.f. paper block condenser, as used motors, fitted 4-pin plug; 14/9, used, as new.

**A.C. Transformer,** input 110v., for use with above transformer, secondaries 10v. and 20v. at 5 amps and 8 amps; 4/9.

**ROLA 10in. 2,000 ohm Energised Speakers,** pentode transformers, with over 11 yards 3-way cable with 5-pin plug, with 4 prong winder, in portable, rexine carrying case, leather handle, brown finish, nickel plated corners. Note, speaker aperture is 8in. only, made for the Pathe cine outfit, and used with the Amplifier chassis, above, size 16 1/2 in. square, 7 1/2 in. deep, cases slightly soiled or marked, overall condition good. 15/9 each, complete.

**SPEAKER Portable Cases** as Above (with cable winder), slightly soiled or marked, fittings tarnished, 5/9. Amplifier cases, ditto condition, size 20x14x12 in, in rexine, 4/9. Roia speakers as above, less case and cable, 9/6.

**BLOCKS** Containing Two Large Capacity Mansbridge Condensers, low voltage for cathode bypass, inverted chassis type; 1/6 each.

**AMERICAN Valves,** sets three, 2-volt American bases, 1A4 VM/HFP, 1B4 HFP, 2101 1/2-watt output Pentode; 6/6 the set of three; suit Philco sets.

**R.C.C. Units** on Small Paxolin Panel, comprise T.C.C. 0.01 mica condenser, 0.15 non-inductive tubular, 2 meg. and 4 meg. 1/2-watt resistances; two for 1/6.

**CLIX Chassis Valve Holders,** 5-pin shield pattern and 7-pin lemon and circular; 2/3 dozen.

**KNOSBS**—Small brown Ultra pattern, 1/3 dozen. Plug and socket 3-position, as used for mains input adjustment, 3 1/3. Large Goldtone HF mains chokes, heavy duty, two for 1/6; may be slightly soiled.

**DOUBLE Trimmers** on Paxolin ex GEC, single ditto, 2/- dozen. TMC .5 m.f. Mansbridge type tubulars, three for 1/3. Ferranti wire wound resistances, nickel end caps, no holders, 4,000, 6,000, 8,000, and 35,000 ohms, four for 1/3, may be slightly soiled.

**TWIN Rubber Cable,** heavy duty (001), suitable for vacuum, irons, etc., ideal for low extension Speaker leads, double vulcanised, in single container of tough rubber, 4/9 dozen yards, or 43/9 per 151 yards.

**SINGLE Rubber,** 16/36, various colours, about 1 1/2 mm., in 500 yard coils, 21/6 per coil. 250-yard coils push back connecting wire, 15/-.

**WELL-KNOWN Make 1-watt Resistances,** limited quantity, sizes available 300, 400, 2,000, 3,500, 25,000, 40,000, 1/2 meg., 1 meg., 2 meg., 2/6 dozen.

**MATT Speaker Cloth,** light colour, 36in. wide, cuts into nine 12in. squares, slightly soiled, takes lacquer paint well; 2/6 yard.

**G.E.C. "Tunecons" Tuning Indicators,** as used in the A.V.C. Five, 1/3 each. Slow motion (epicyclic) drives, fit 1/4in. shafts, long 1/4in. spindle, ratio 8-1, 1/3 each; well made in brass, with ball bearings.

**SATOR Midget Volume Controls,** less switch, 1 meg., 400,000 ohm., and 100,000 ohm., 1/3 each.

**PAXOLIN Strip,** 2 1/2in. wide, as used for group boards, etc., three 12in. lengths for 1/6.

**RESISTANCES,** 2-watt, well-known make, 7,500 and 9,000 ohm., three for 1/3; 370 ohm. 3-watt, two for 1/3.

**SPECIAL Note**—We are now confining our business to mail orders, and shall be able to give prompt attention from a quiet situation—G. A. Ryall, "Arnehurst," Marsh Lane, Taplow, Bucks. [9531]

**VAUXHALL**—Rola 8in. P.M. speakers, with transformer, 14/9; 3-gang bandpass H.F. iron-cored tuning coils, 19/6; one-gang resistors, 4d.

**VAUXHALL**—Mica condensers, 0.001 and 0.002 mfd., 4d.; paper tubulars, 0.25 mfd., 6d.; 0.001 mfd., 4d.

**VAUXHALL**—Cosmocond pick-ups, 11/- and 18/9; Nicolet 3/4 L.F. transformers, 5/9.

**VAUXHALL UTILITIES,** 163a, Strand, London, W.C.2. Postage paid orders over 3/-. Send 1d. stamp for list. [9530]

**COULPHONE RADIO,** New Longton, Nr. Preston. —Prompt personal service. Brand new goods only. Tungstram Valves, English and American types. Ken Rad 1st grade American valves. Next delivery Cosmocond Crystal pick-ups June. Latest type speakers with transformers, Rola 10in. P.M., 22/6. Goodman's 8in. P.M. (model C/810), 17/6. Electrolytics, 8-8 mfd., 500v., 4 leads, 4/6; 8 mfd., 500v., 2/9; 50v., 50 mfd., 2/9. Erie and Dubilier 1-watt resistors. All standard values 6/6 doz. Stamp for new 1941 (Spring) list. [9535]

# GALPINS

## ELECTRICAL STORES

Owing to War Conditions this business is now transferred to:—

### 21, WILLIAM ST., SLOUGH, BUCKS.

Terms: Cash with Order

**ELECTRIC LIGHT CHECK METERS,** small, late type, well-known makers, in good condition, electrically guaranteed for 200/250 volts 50 cy. 1 phase A.C. mains. 5 amp. type, 6/-; 10 amp., 7/6; 20 amp., 9/- each. Post 1/- on all types.

**D.C. ELECTRIC LIGHT CHECK METERS,** 200/250 volts 5 and 10 amps., 4/6 each, post 1/- (in new condition).

**PHILIPS HIGH VOLTAGE CONDENSERS.** Infd. at 4,000 volt working, 5/6 each, carriage 1/6.

**EX R.A.F. GLASS ACCUMULATOR TANKS,** 5x5x8in., new and unused, 3/6 each, post 1/-.

**EX R.A.F. SWITCH PANEL,** with case (new), fitted 6 small knife switches, leads, cords and cleats, complete in wood case, 2/6 each, post 6d.

**HIGH-VOLTAGE TRANSFORMERS,** useful for all test work or television. Input 200/240 volts, output 5,000 and 7,000 volts, 7/6 each, post 1/-.

**VOLTAGE CHANGING TRANSFORMERS (Auto Wound),** 100/110 to 200/240 v., or vice versa, fully guaranteed, 1,000 watts, 60/-; 2,500 watts, 110/-.

**DUG-OUT LAMPS, EX R.A.F.,** solid brass construction, glass dome, complete with 12-volt bulb (any bulb can be fitted), wall fitting, 3/- each, post 6d.; Ditto, wing type, as new, 2/6, post 6d.

**DUG-OUT LAMPS, EX R.A.F.,** porthole type, or can be bracket fitted, glass dome, three colour fitting, white, red or green, solid brass construction, 6in. dia., complete with bulb; any size bulb can be fitted. Price 5/-, post 6d.

**EX R.A.F. AUTOMATIC CHARGING CUT OUTS AND VOLTAGE REGULATORS,** to suit any dynamo up to 20 volts at 15 amps., fully adjustable, wiring instructions, complete in metal case. Price 3/6, post 9d.

**DYNAMOS,** all shunt wound and fully guaranteed, 50/75 v.-15 a., £6/10/-; All carriage forward.

**25-VOLT D.C. MOTOR,** maker "Crompton," 1/2 h.p., ball bearing, in perfect order, £3, carriage forward.

**110-VOLT D.C. MOTOR,** totally enclosed, rated at 8 amps., ball bearing, in new condition, make good slow-speed dynamo, £2/5/-, carriage forward.

**GURMETAL PULLEYS,** 7in. diameter, to take 1in. dia. rope, complete with rope guard and hook, 7/6 each, post free.

**PHILIPS TRANSFORMERS,** 220 v. input, output 2,000-0-2,000 volts, 200 m.a. and 2 L.T.s., 50/-, carriage forward.

**1/2 HP 110 v. D.C. MOTOR,** in good working order, 25/-, carriage forward.

**SLIDER RESISTANCE,** 2,500 ohms at 200 m/a, worm and wheel control, 25/-, post free.

**FLOODLIGHTS,** 12in. dia., multi mirror type with 5in. dia. margin spot centre, any bulb can be fitted, 15/-, Carriage paid.

**AERO DYNAMOS,** output 12v.-12 amps., new, 15/- each. Carriage 2/6.

**PRESS-BUTTON UNITS,** 8-way, 7 x 6 x 1 1/2 ins., fitted capacitors, condensers, etc. Price 5/6, post free.

**1 kW AUTO TRANSFORMER CORE** for rewinding, complete with clamps and bobbin. Price 12/6, carriage paid.

**CROMPTON DYNAMO,** output 220 volts, 10 amps., 4 pole, shunt wound. Price £8/10/-, carr. forward.

**ROTARY CONVERTOR, D.C. to A.C.,** input 220 volts D.C., output 85 volts 2 kW., 50 cycle, 3 or 1 phase. Price £5, carr. forward.

**ROTARY CONVERTOR, D.C. to A.C.,** 25 volts input, output 350 volts at 50 m/a. D.C. Price 30/-, carr. paid.

**20 WATT SPEAKER (American),** 110 volt A.C., complete with metal rectifier and speech transformer; in large cabinet. Price £4/10/-, carr. forward.

**LARGE TRANSFORMER,** input 230 volts 50 cycles, output 300-0-300 volts at 6 amps. Price £3/10/-, carr. forward.

**LARGE TRANSFORMER,** input 230 volts 50 cycles, output 300-0-300 volts at 10 amps. Price £5, carr. forward.

**ROTARY CONVERTOR** for charging. Input 220 volts 50 cycles A.C., output 12 volts 10 amps D.C. Price £5/10/-, carr. forward.

**BELL PUSHES,** ex-G.P.O., solid ebonite, two silver contacts, as new, 1/6, post free.

**MILLIAMMETERS,** 2-in. dia., 0-30, 25/-; ditto, 0-150, 25/-; ditto, 2 1/2-in. dia., 0-100, 25/-, post free.

**TUNGSTEN CONTACTS,** new, one fitted screw and one fitted blade, 1/9 the pair, post free.

## RADIO CLEARANCE, Ltd.

**PLESSEY 4-waveband Coil Units,** with switching, fully screened pre H.F. stage, 465 k/C oscillator, 13 metres, 2,000 metres, 21/- each; no diagrams available; I.F. transformers, 2/6 each extra; gang condensers for same, 2/11 each.

**LISSEN 2v. Battery Pentodes,** 4-pin side terminals, L.P.T.2A; 4/11 each.

**LOW Loss Ceramic Valve Holders,** Lissen Hi-Q baseboard and chassis, 7-pin; 1/- each.

**LOW Loss Short Wave Condensers,** variable ceramic L, insulation, brass vanes, Lissen Hi-Q minimum capacity, 5 mfd., 2Q mfd.; list 5/6 each, our price 2/6 each.

**PUSH-PULL Switch,** Lissen 2-point. 4d. each; 3-point. 6d. each.

**YAXLEY Type Switches,** 4-pole, 3-way. 9d. each.

**YAXLEY Type Switches,** 4-bank, 2-pole, 4-way; 2/6 each.

**YAXLEY Type Switches,** 6-bank; 3/- each.

**YAXLEY Type Switches,** 9-bank; 3/6 each.

**ROLA P.M. Speakers,** latest model, 7 1/2 in. cone with power-pentode transformer, boxed; 17/6 each.

**CLOCK-FACED Dials,** 5in. x 5in., with printed scale, 4 wares; 2/6 each.

**STRAIGHT Line 3-waveband Dials;** 1/11 each.

**MAINS Transformer**—300-0-300v. 80 m.a. 5v. 2 amps., 6.3 5 amps., drop through chassis type; 12/6 each.

**MAINS Transformers**—Wearite 100 watt auto transformers, 100-110v., 200-250v., reversible; 14/11 each.

**CHASSIS Mounting Valve Holders,** American Octals; 6d. each.

**CHASSIS Mounting Valve Holders,** English Clix type, 4-5-7-pin; 3d. each.

**CELESTION Valve Holders,** 5- and 7-pin chassis type, 4d. each; baseboard type, 5-pin, 2d. each.

**CENTRALAB Volume Controls,** Midget type, 2,000, 5,000, 25,000, 50,000, 100,000 ohms, less switch, 2/9 each; L.000, 25,000, with switch, 3/6 each.

**PRESS Button Units,** 6in. x 6in. x 2in., complete with 6 press buttons and capacitors; 4/11 each.

**PLESSEY Motor Tuning Units,** including fractional h.p. A.C. motor for 12v. continual running on 24 volt, intermittent running and 2-gang 0.0005 condenser; 8/6 each.

**11-WAY Push Button Switches,** 1/6 each; 10-way push-button switches, 1/6 each; 8-way push-button switches, 1/3 each; 4-way push-button switches, 1/3 each.

**DROPPING Resistances** for All Purposes, total resistance 535 ohms, 5 taps in steps of 50 ohms. standard for Pye, Lissen, Ever Ready, etc.; 3/6 each.

**RESISTANCES,** 100 ohms, 10 watt; 1/- each.

**10 FT. Coils** Connecting Wire, glazed; 4d. each.

**PUSH-ON Pilot Lamp Holders;** 3d. each.

**PLESSEY Single Gang 0.0005 Variable Condensers,** 1/11 each; 2-gang 0.0005 variable condensers, with vernier control, 1/11 each.

**PERMUABILITY Tuned Press Button Units;** 2/6 each.

**1. Wire End Bias Electrolytics,** 50 mfd., 12 volt; 1/5 each.

**TUBULARS,** wire-end non-inductive paper condensers, all sizes up to 0.01, 5d. each; 0.1, 7d. each.

**T.C.C. 2 mfd. Electrolytic Condensers,** 200v. working; 1/3, each.

**CONDENSERS, 0.0005 Twin,** 1/3 each; triple, 1/9 each.

**WESTON Meters,** 0.50 m.a. and 0.300 m.a., moving coil type; 25/- each.

**LB. Reels 16 and 20 gauge Tinned Copper Wire;** 2/6 each.

**CAN Electrolytics,** 12x16 mfd., 525 volt peak, with clip fitting; 3/11 each.

**CAN Electrolytics,** 8x8 mfd., 450v. working, with clip fitting; 3/11 each.

**T.C.C. 1x1 mfd. Paper Condenser,** 250 volt A.C. working, 450v. D.C. working; 1/11 each.

**T.C.C. 1 mfd. Paper Condenser,** 350v. working; 1/- each.

**DOUBLE Fuse Holders,** complete with two 1in. fuses; 1/6 each.

**WE Have in Stock a Large Selection of High Voltage Paper Condensers,** all capacities, too numerous to advertise; advise interested clients to call; also large selection of high voltage transmitters and chokes.

**ALL Orders Must Include Sufficient Postage to Cover Hours of business; Week-days 9-4.30, Saturdays 9-1 p.m. Please write your name and address in block letters. We cannot undertake to answer enquiries unless full postage is included (2 1/2d.).**

**RADIO CLEARANCE, Ltd.,** 95, High Holborn, London, W.C.1. Telephone: Holborn 4631. [9524]

**A.C.-D.C. Converter,** Rola auditorium speaker, wired up chassis without valve, including tube American all-wave tuners; offered to best bidder.—E. J. Forbat, 8, Charing Cross Rd. [9532]

**L.T. Metal Rectifiers,** 12v. 1 amp., complete with transformer and ballast lamp, 22/9, charges 2 to 12 volts; instrument type metal-rectifiers, 8/6, post 4d.; high fidelity crystal microphones, famous maker, £2/12/6, post 6d.—Champion, 42, Howitt Rd., London, N.W.3. [9539]



# WARD AC/DC ROTARY CONVERTERS

for operating P.A. Amplifiers, Radio Receivers, etc.



## WE ALSO MANUFACTURE

DC/DC ROTARY TRANSFORMERS, SMALL ALTERNATORS, SMALL DC MOTORS, H.T. GENERATORS, MAINS TRANSFORMERS up to 10 k.v.a. PETROL ELECTRIC generator sets up to 50 k.v.a. BATTERY CHARGERS for private and industrial use, and are fully equipped for general small engineering work. Full details of any of the above upon request. Export enquiries invited.

**CHAS. F. WARD**

46, FARRINGDON ST., LONDON, E.C.4.  
Telephone: Holborn 9703. Works: Bow, K.



## No overheating with Solon Electric Soldering

Overheated irons need filing and retinning; a laborious or troublesome job—cut it out by using a SOLON. With Solon Electric Soldering, in 4 minutes, the bit gets to the correct heat and stays there—just as long as you need it; 15 hours' use takes only 1 unit. No flame—no dirt. The constant heat, at the point, makes the solder run sweetly; sweats it right into the joint; gives you a strong neat job.



Made for following standard voltages:—200/220, 230/250.



Handyman model supplied complete with Resin-Cored Solder, Flex and Lamp Adaptor **9/4**

Solon Resin-Cored Solder **6d.** per reel.

W. T. HENLEY'S TELEGRAPH WORKS CO. LTD.  
(Dept. 24/E), Engineering Sales Dept., Milton Court,  
WESTCOTT, DORKING, SURREY.

**RECTIFIER** Units, A.C., input 200-250 volts 50c., D.C. output 9v. 3 amp., in steel boxes suitable for charging, etc.; £3/5.

**ELECTRO-MAGNETIC** Counters, resistance 500 ohms, counting from 1 to 12,999, 9/6; smaller type, 1 to 1,999, 5/6; useful for innumerable purposes.

**RELAYS** for Operation on 2 volts D.C., with 6-way make or break switches, many useful applications, limited number; 5/-.

**AUDAK** Pick-up Heads, high resistance coil, 6/6; Audak Cutting Heads (heavy duty), 3-5 ohm. coil, high quality instrument, 17/6.

**SINGLE** Earpieces, with flexible metal sheathing, chrome plated; 2/6.

**WESTINGHOUSE** Rectifiers, type H.T.8, slightly used, guaranteed O.K.; 8/6.

**COMPLETE** Motor-drive Tuning Assembly, including 2-gang 0.0005 condenser, tuning motor with muting switch and homing commutator and station selector; with 8-button push-button switch, 25/-; full details supplied.

**SMALL** Reversible A.C. Motors (as used for motor tuning), 25-30 volts A.C., built-in reduction gear spindle, speed about 60 r.p.m., a first-class job with hundreds of applications; 8/6.

**TAPPED** Mains Resistances for 0.2 amp. valves tapped 200, 230-250; 4/-.

**ASSORTED** Resistances, Eric, etc., our selection; 1/6 doz.

**3-WAY**, 4-pole switches, Rotary type; 1/6 each.

SEE Last Month's Issue for Amplifiers.

**LONDON CENTRAL RADIO STORES**, 23, Lisle St., London, W.C.2. Phone: Gerrard 2969. 19542

**Wanted**

**WANTED**, Premier High Fidelity tuning unit; reasonable price given.—Box 2575, c/o *The Wireless World*. [9511]

**BLANK** Discs Wanted, direct recording (not aluminium surface), new condition.—H. Brady, 21, Beaumont St., Oxford. [9543]

**WANTED**, Telefunken 1001 pick-up, new or second-hand, in good order.—Please write, stating price, to Box 2576, c/o *The Wireless World*. [9513]

**WANTED**, large P.M., M.C. speakers by best makers, all types of valves, mains transformers, meters, etc.—W. T. Rickards, 22, Salter Rd., Tipton. [9518]

**GRAMOPHONE MOTORS**

**Wanted**

**RECORD** Changers and Gram Units, 500 wanted for cash, full prices paid; £2/10 paid for H.M.V., etc., record players any condition.—27, Worcester St., Wolverhampton. [9506]

**METERS, ETC.**

**Wanted**

**WANTED**, test meters, milliamp. meters, voltmeters, d.c. and a.c., etc.—W. T. Rickards, 22, Salter Rd., Tipton, Staffs. [9494]

**TEST EQUIPMENT**

**Wanted**

**COSSOR** Double Beam Oscillograph, impedance bridge, Weston Universal meters, Model 7 Avometer, valve voltmeters, and milliameters, flush type required; all apparatus must be in good condition.—Grampian Reproducers, Ltd. Kew Gardens, Surrey. [9502]

**TUITION**

**RADIO** Training.—P.M.G. exams. and I.E.E. Diploma; prospectus free.—Technical College, Hull. [0611]

**MORSE** Code Courses.—"Book of Facts," free.—Candler System Co. (Room 55 WO), 121, Kingsway, London, W.C.2. [9074]

**PRACTICAL** Postal Courses, radio television, test equipment design, trade-test coaching for R.A.F. post, I.P.R.E. and I.W.T. exams; booklet free.—Secretary, I.P.R.E., Bush House, Walton Av., Henley-on-Thames. [9328]

**RADIO** Engineering, Television and Wireless Telegraphy; comprehensive postal courses of instruction.—Apply British School of Telegraphy, Ltd., 179, Clapham Rd., London, S.W.9 (Estd. 1906). Also instruction at school in wireless for H.M. Merchant Navy and R.A.F. [9249]

**SITUATIONS VACANT**

**AIR** MINISTRY.  
**CIVILIAN** W/T. Operators Required, age 21 to 45, preferably with 1st Class P.M.G. or Air Operator's Certificate in Wireless Telegraphy, and experience in Radiotelephony, Direction Finding and Wireless Maintenance work.

**SALARY** 75/- a week, rising to 125/- a week, plus a temporary work bonus of 5/- a week on the earlier points of the scale.

**APPLY** by postcard for Application Form and full particulars to the Under-Secretary of State, Air Ministry (S.1(e)), Julian Rd., Bristol, 9. [9420]

**BOROUGH** POLYTECHNIC, S.E.1.

**APPLICATIONS** Are Wanted for Part-time Evening Teachers of Electrical Engineering and Ancillary Subjects for the Ordinary and Higher National Certificates, for radio communication, technical electricity, telephony and installation work.—Application to be made to the Principal, Borough Polytechnic, London, S.E.1, as soon as possible. [9504]

# BOOKS

## THE SUPERHETERODYNE RECEIVER

by Alfred T. Witts. "Gives all the information necessary for a complete understanding of the Superheterodyne Receiver," says PRACTICAL WIRELESS. Fourth edition. 4/6 net.

## INTRODUCING RADIO RECEIVER SERVICING

by E. M. Squire. One of the best books available on this subject. Handy and concise, it gives a sound knowledge of receiver operation and equipment without unnecessary theoretical frills. 6/- net.

## CATHODE RAY OSCILLOGRAPHS

by J. H. Reyner. A simple and authoritative guide to the practical application of cathode ray tubes to the examination of oscillations or wave-forms and to numerous other purposes. The treatment is based on practical experience extending over many years. 8/6 net.

# PITMAN

Parker Street, Kingsway, W.C.2

## QUICK COURSE IN MORSE

by R.A.F. Signallers

### on COLUMBIA Records

- A complete new course of instruction in Morse Code made with the co-operation of R.A.F. Signallers. From the Alphabet to Fast Transmission with varying degrees of typical jamming. Invaluable to those about to join the Fighting Forces, A.T.C., or Merchant Service.
- What an advantage to enter, already proficient in this important part of the training!
- Start now—ask your local dealer about these records—today!
- 4 Records DB 1995-98 12/- (+ 2/8d. Tax)
- Booklet of instruction included

# A COUSTICAL MANFG CO.

SPECIALISTS IN

Amplifiers, Transformers, and all Sound Equipment

have (owing to enemy action) removed to:

138-140, WARDOUR STREET, LONDON, W.1,

where our full services are available.

## THE INSTITUTE OF WIRELESS TECHNOLOGY

(Founded in 1925. Incorporated 1932)

### PROFESSIONAL MEMBERSHIP

The advantages of professional membership are open to all qualified wireless engineers.

Full information, with syllabus, may be obtained from the Assistant Secretary, Institute of Wireless Technology, 25, Firs Drive, Palmers Green, London, N.13.

Phone: PALMERS GREEN 2413.

## BOOKS on WIRELESS

Write for complete list to  
ILIFFE & SONS LTD.

Dorset House, Stamford St., London, S.E.1 w.w.





**TRANSFORMERS & CHOKES**  
by  
**PARTRIDGE**  
a guarantee in itself

If your work is for the Government and you are experiencing difficulty in obtaining transformers from your usual source, please get into touch with us.

We can still give prompt deliveries providing your order quotes the number of the Government contract for which the goods are required. The latter is essential.



King's Bldgs., Dean Stanley St., London, S.W.1.  
Phone: VICTORIA 5035

*This space reserved for*



**W. BRYAN SAVAGE LTD.**

**TRIX SOUND EQUIPMENT**

**RELIABLE AMPLIFICATION**  
The TRIX ELECTRICAL COMPANY LTD.  
65, Bolsover St., London, W.1. Euston 5471

**SPECIAL OFFER OF AUTOMATIC MORSE CODE SENDERS**  
(Patented). These instruments are indispensable for the rapid learning of the Morse Code. No practice or preparation is necessary for anyone—even a child—to send immediately in any order, perfect Morse signals at speeds from 5-30 w.p.m. Replaces ordinary key for operating buzzer, oscillator, etc. International Code (41 characters). Unassembled, with full instructions for constructing, 4/6; only baseboard (no special type) required extra. Instrument complete on baseboard, 6/6. Superior 2-6 volt Buzzers, 2/6.  
All goods post-paid.

**MIDLAND INSTRUMENT CO.**  
74, GOSFORD STREET, COVENTRY.

**WIRELESS Technical Instructors Required in Army Units.**

**EMOLUMENTS.**—Pay 8/9 per day (7 days a week); clothing, rations and accommodation, or if this cannot be provided allowances at authorised rates; if married and otherwise eligible, family allowance payable in respect of wife and children, subject to allotment from pay.

**CANDIDATES** Should Preferably be under 35 and over 24, and

- (A) Hold one of the following qualifications:—  
Graduatehip of the Institution of Electrical Engineers.  
Final (Grade III) Certificate of City and Guilds of London Institute Examination in Radio Communication.  
Higher National Certificate in Electrical Engineering.  
Certificate of City and Guilds of London Institute in Radio service work.  
Or

- (B) Be able to pass an examination on the following syllabus:—  
Simple algebra, including quadratic equations; simple trigonometrical ratios and identities; vectors.  
Properties of electrical currents; heating of conductors; magnetic fields; unit of current; Ohm's Law; resistance in series and parallel; potentiometers.  
Magnetic effect of current fields due to parallel wires; field due to a solenoid; electro-magnets. Meters.  
Induction; effect of rotating a coil in a magnetic field.  
Mutual and self induction and inductance; effect of inductance on growth and delay of current.  
Capacity; charging storage and discharge of condensers; through resistance and inductance.  
Alternating currents; vector diagrams; effect of resistance variation; effects of L and C in A.C. circuit; phase difference of currents; resonance in a series circuit; parallel circuit of L and C; Q factor.  
Elementary knowledge of valves; simple theory of amplifiers, oscillators and detectors; general principles of radio practice.

**SUITABLE** Candidates will be interviewed at Local Centres, and, if successful, will be enlisted and appointed Acting Sergeant Tradesman. For those who are on the Schedule of Reserved Occupations, special arrangements will be made to enable them to be enlisted. In the event of any applicant found to be reserved under Schedule of Reserved Occupations special application will be made for relaxation of the Schedule. No guarantee can be given that this application will be successful.

**APPLICATION** Forms may be Obtained by Postcard from the Under-Secretary of State, The War Office (A.G.6c), Whitehall, S.W.1. [9520]

**RADIO** Engineer, capable taking charge service department, must be exempt (Warrington); £5 per week.—Box 2571, c/o *The Wireless World*. [9496]

**CAPABLE** Radio Engineer, must be exempt; good salary and prospects; state experience, age, etc.—Dawsons, Ltd., 59, Sankey St., Warrington. [9497]

**RADIO** Service Engineer, exempt military service, required by West End firm; if necessary tuition given in fault finding on latest sets. Permanent job, good wages.—Wilkins, 56, Gloucester Rd., S.W.7. [9503]

**THE** British Broadcasting Corporation.—**APPLICATIONS** are invited for a limited number of **APPOINTMENTS** to the **UNESTABLISHED STAFF** for the duration of the war, in the **OVERSEAS AND ENGINEERING INFORMATION DEPARTMENT**. **COMMENCING** Salary will be Dependent on Qualifications and Experience, with annual increments to scale subject to satisfactory service, to a maximum of £400 per annum.

**CANDIDATES**, who must be of British nationality and parentage, should have a keen interest in short-wave reception, with experience of short-wave transmission and reception, preferably within the Empire, possess some recognised theoretical qualifications in radio communication and be capable of dealing with technical correspondence. Successful candidates will be appointed to London in the first instance, but must be prepared to proceed elsewhere if needed. Future permanent employment will be determined by merit and the existence of vacancies. Further details of the conditions of employment in the service will be given to candidates selected for interview.

**APPLICATIONS**, giving full details of education, qualifications, and experience, should be forwarded to the Engineering Establishment Officer, Broadcasting House, London, W.1. Envelopes should be marked O. & E.I.D. Candidates who wish to have their applications acknowledged and to be informed if their applications are unsuccessful should enclose two stamped addressed envelopes. [9510]

**RADIO** Designer Required, thoroughly experienced and acquainted with modern design and practice, good salary, but applications only considered from first class men of proved experience.—Box 2573, c/o *The Wireless World*. [9508]

**IMMEDIATE** Position Available to Man with Comprehensive Knowledge of 16 mm. Sound on Film Projectors; must be capable of carrying out all repairs to projectors and amplifier speakers; good salary to right man; accommodation provided if necessary.—Write, giving full details of experience to Box 2572, c/o *The Wireless World*. [9498]



**FOR THE RADIO SERVICE MAN, DEALER AND OWNER**

The man who enrolls for an I. C. S. Radio Course learns radio thoroughly, completely, practically. When he earns his diploma, he will KNOW radio. We are not content merely to teach the principles of radio, we want to show our students how to apply that training in practical, every-day, radio service work. We train them to be successful!

**INTERNATIONAL CORRESPONDENCE SCHOOLS**

Dept. 38, International Buildings, Kingsway, London, W.C.2.  
Please explain fully about your instruction in the subject marked X.

- Complete Radio Engineering
  - Radio Service Engineers
  - Elementary Radio
  - Television
- If you wish to pass a Radio examination, indicate it below,  
Inst. of Wireless Technology  
P.M.G. Certificate for Wireless Operators  
Provisional Certificate in Radio Telephony and Telegraphy for Aircraft  
City and Guilds Telecommunications

Name ..... Age .....  
Address .....  
(Use penny stamp on unsealed envelope.)

**ARE YOU FIT— for high-speed CODE work?**

Speed and accuracy in code work is only obtained by those who train both their mind and body. The better your health the greater your progress. This important side of training is fully covered by the Candler System Advanced Code Course. It is not a system of physical culture in the general sense to which the term is applied. The Candler System is devised for the Physical and Mental Training of TELEGRAPH OPERATORS. For further details see pages 4 and 5 of the Candler "Book of Facts." Fill in the Coupon below and get a copy free.

Particulars of the Candler Junior Code Course and Telegraph Touch-typewriting are also given in this interesting book.

The **ADVANCED** and **High-Speed** Telegraphing Course is for operators who want to increase their w.p.m. speed and improve their technique.

The **JUNIOR** Scientific Code Course is a complete course for beginners. It teaches all the necessary code fundamentals scientifically.

The **TELEGRAPH** Touch-Typewriting Course is a special course for telegraphists who want to become expert in the use of the typewriter for recording messages.

Courses supplied on Cash or Monthly Payment terms.

**COUPON**

Please send me a Free Copy of Candler "Book of Facts."

NAME.....  
ADDRESS.....  
.....  
Post Coupon in Id. unsealed envelope to London Manager  
**CANDLER SYSTEM CO. (55.W.),**  
121, Kingsway, London, W.C.2.  
Candler System Co., Asheville, North Carolina, U.S.A.



**TECHNICAL TRAINING**

**G**REAT Possibilities Exist for Technically Qualified Engineers, key men in wartime and afterwards. Through the home-study courses of The T.I.G.B. take a recognised engineering qualification such as A.M.I.Mech.E., A.M.I.E.E., A.M.I.R.E., A.F.R.Ae.S., A.M.I.Chem.E. C and G, etc., in which examinations the T.I.G.B. students have gained 25 FIRST PLACES and Hundreds of Passes. Write to-day for "The Engineer's Guide to Success"—Free—containing the world's widest choice of engineering courses covering all branches, including Aeronautical, Mechanical, Electrical, Wireless, Chemical, etc.  
**T**HE TECHNOLOGICAL INSTITUTE OF GREAT BRITAIN, 82, Temple Bar House, London, E.C.4. [9335]

**REPAIRS AND SERVICE**

**L.T.P. (LONDON TRANSFORMER PRODUCTS, Ltd.)**, Willesden, N.W.10. Willesden 6486 (3 lines). [9227]

**M**AIN'S Transformers, chokes, output transformers, etc., rewound.—Davies, 30, Morley Av., Manchester, 14. [9524]

**E**POCH, Epoch—Genuine replacement diaphragms for all models.—R.E.C.S., Crown St., Reading. Phone: 2796. [9529]

**M**AIN'S Transformer Service, repairs, rewinds, or construction to specification of any type, competitive prices and prompt service.—Sturdy Electric Co., Dinton, Newcastle-on-Tyne. [0516]

**A**LL Types of Receivers and Amplifiers Serviced; aligning and testing constructor's sets a speciality. Competitive prices.—S.A. Radio, 293, Norwood Rd., S.E.24. [9499]

**"SERVICE with a Smile."**—Repairers of all types of British and American receivers; coil rewinds; American valves, spares, line cords.—F.R.I., Ltd., 22, Howland St., W.1. Museum 5675. [8934]

**METROPOLITAN RADIO SERVICE**—Guaranteed repairs to American and British receivers; linecord resistances, Majestic I.F. transformers, and rewinds; trade supplied.—1021, Finchley Rd., N.W.11. Speedwell 3000. [0435]

**MORSE EQUIPMENT**

**F**ULL Range of Transmitting Keys, practice sets and other equipment for Morse Training.—Webb's Radio, 14, Soho St., London, W.1. Phone: Gerrard 2089. [9409]

**BUSINESSES FOR SALE OR WANTED**

**"THE Wireless and Electrical Trader"** is an essential part of the equipment of every Wireless Trader, its pages reflect the very latest turn of trade events, and it is read by all the leading dealers and manufacturers, for particulars of businesses offered or wanted. By subscription, to the trade only, 17/6 per annum, post free.—Send your trade card for specimen copy 1: Dorset House, Stamford St., London, S.E.1. [0614]

**VACUUM CLEANERS**

**F**IVE Left, £15/15 Tullus super electric cleaners, £5/5 each, accessories included; also Electrolux, Hoovers, Hotpoints, Goblins, Vactrics, from £6/6; all rebuilt, guaranteed one year.—"R.E.C.S.," Crown St., Reading. Phone: 2796. Exchanges, spares, bags, brushes, belts for all makes in stock. We buy Hoovers in any condition. [9527]

**"ENGINEERING OPPORTUNITIES"**

This unique Handbook shows the easy way to secure A. M. I. C. E., A. M. I. Mech. E., A.M.I.E.E., A.M.I.A.E., A. M. I. W. T., A.M.I.E.E., and similar qualifications. **WE GUARANTEE—NO PASS—NO FEE.** Details are given of over 150 Diploma Courses in all branches of Civil, Mech. Elec., Motor, Aero. Radio and Production Engineering, Draughtsmanship, Tracing, Inspection, Government Employment, **BUILDING (the great after-war career)**, R.A.F. **MATHS**, etc. Write for this enlightening Handbook to-day. **FREE** and post free. Men with Radio knowledge can obtain attractive posts in the Service.  
**BRITISH INSTITUTE OF ENGINEERING TECHNOLOGY**, 387 Shakespeare House, 17, 18, 19 Stratford Place, London, W.1

**METAL CASES**

**FOR RADIO & RADIO INSTRUMENTS**  
 also  
**CASES & BOXES IN WOOD & REXINE**  
**MANUFACTURERS**  
 of  
**FABRICATED PARTS IN WOOD AND METAL TO THE RADIO AND AIRCRAFT INDUSTRY**  
 Send 2d. in stamps for details of **RADIO CABINETS FOR THE HOME.**  
**LOCKWOOD & CO.,** Lowlands Road, Harrow, Middlesex. Phone: **BYRON 1818.**

**FOR SHORT-WAVE COMPONENTS**

Communication Receivers for work of National importance; and all accessories for short-wave work and experiments. Call or write to  
**WEBB'S RADIO**  
 14 SOHO ST., OXFORD ST., LONDON, W.1.

**VACUUM CLEANERS**

**H**OOVERS Wanted, any condition; cash waiting.—"R.E.C.S.," Crown St., Reading. Phone: 2796. [9528]

**PRINTING**

**C**ARDS, memos, billheads, 1,000 7/6; rubber stamps, samples.—"B" Tices, 11, Oaklands Grove, London, W.12. [9410]

**BOOKS, INSTRUCTIONS, ETC.**

**A**MATEUR Radio Handbook, 328 pages, 300 illustrations, by post 4/2.—Radio Society of Great Britain, 16, Ashridge Gardens, London, N.13. [9505]

**W**EBB'S Radio Map of the World Enables You to Locate Any Station Heard. Size 40in. by 30in. 2-colour heavy art paper, 4/6, post 6d. Limited supply on linen, 10/6, post 6d. Webb's Radio Globe, superb 12in. full-colour model. Radio prefixes, zones, etc. Heavy oxidised mount. Post paid, 27/6.—Webb's Radio, 14, Soho St. London, W.1. Phone: Gerrard 2089. [9408]

**E**VERY Radio Dealer Who is Not a Regular Reader of "The Wireless and Electrical Trader" should send his trade card at once for a specimen copy and full details of the "Trader" Services. "The Wireless and Electrical Trader" has the widest influence, and is read by all the leading manufacturers and traders. Trade only, 17/6 per annum, post free. Published at Dorset House, Stamford St., London, S.E.1. [0615]

**T**HE "Wireless World" Great Circle Projection Map (on a Zenithal Azimuthal Graticule) gives the true distance and direction of every point in the world from London. Complete with scales and full explanatory notes, size 29in. x 34½in., price 2/- post free.—Iliffe and Sons Ltd., Dorset House, Stamford St., London, S.E.1.

**H**ANDBOOK of Technical Instruction for Wireless Telegraphists." By H. M. Dowsett, M.I.E.E., F.Inst.P., M.Inst.R.E. Sixth Edition. A standard handbook for wireless operators containing a complete theoretical course for students anxious to qualify for the Postmaster-General's Certificate of Proficiency. Price 21/- net. By post 21/9, from Iliffe and Sons Ltd., Dorset House, Stamford Street, London, S.E.1.

**"R**ADIO Data Charts." By R. T. Beatty, M.A., B.E., D.Sc. Second edition. A series of Abacs providing most of the essential data required in receiver design and enabling problems to be solved without having recourse to complicated mathematical formulae. Price 4/6 net. By post 4/11, from Iliffe and Sons Ltd., Dorset House, Stamford St., London, S.E.1.

**"W**IRELESS Direction Finding." By R. Keen, B.Eng. (Hons.), Sheffield, A.M.I.E.E., Third Edition. Covers the latest developments, including medium- and short-wave Adcock systems and deals with Beacon Transmitters, Aircraft Approach and Blind Landing processes. There are also detailed descriptions of Commercial Shore, Ship and Aircraft Installation. Price 25/- net. By post 25/9, from Iliffe and Sons Ltd., Dorset House, Stamford Street, London, S.E.1.

**THE SIMMONDS GROUP**

**INVENTORS**

We continually seek new inventions and products in all branches of industry for development and production by the manufacturing Companies of the Simmonds Group throughout the world.

**SIMMONDS DEVELOPMENT CORPORATION LTD., BUSH HOUSE, W.C.2.**



**WHY LEAVE YOUR SPEAKER AT HOME?**

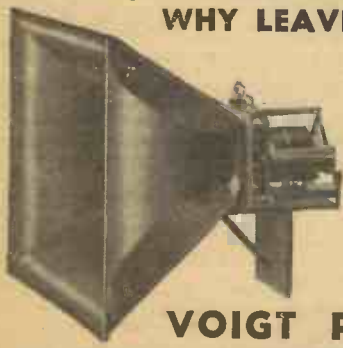

Our Compact 2ft. mouth HORN, for limited space and clear speech, unbolts and is ideal for packing.

Price - - **£4 - 16 - 3** (ex works)

**UNIT WITH TWIN DIAPHRAGM**  
**£15 - 15 - 0**

(about 40 watts required for full excitation)

**VOIGT PATENTS LTD.**

**THE COURTS, SILVERDALE, SYDENHAM, S.E.26**  
 Telephone: SYDenham 6666.

**MELTON METALLURGICAL LABORATORIES LTD**

**LIQUID SILVER**

for metallising **CERAMIC, MICA, QUARTZ** or **GLASS.**

Low melting-point **SOLDER** from 70°C. or to specification. Non-corrosive Liquid **FLUX** for all electrical or Radio purposes.

*Pre-War deliveries. Overseas enquiries invited.*

**IPSWICH RD., TRADING ESTATE, SLOUGH, BUCKS.** Phone: Slough 20992



# ROLA

## LOUD SPEAKERS

THE WORLD'S FINEST REPRODUCERS

## TRANSFORMER LAMINATIONS

Core Width  $\frac{3}{8}$ " to  $1\frac{1}{2}$ " (E's & I's)

### EIGHT STOCK SIZES

A Comprehensive Bulletin together with details of Associated Covers and Clamps with design data will be sent to manufacturers on request.

### BRITISH ROLA LIMITED

MINERVA RD., PARK ROYAL, N.W.10. WILlesden 4322

## WHY YOU SHOULD USE ONLY

# ERSIN MULTICORE

## THE SOLDER WIRE WITH 3 CORES OF NON-CORROSIVE ERSIN FLUX

- Avoids Dry Joints
- Increases Electrical Efficiency of Joints
- Speedily makes Sound Joints on Dirty or Oxidised Surfaces
- Always Correct Proportions of Flux and Solder
- No Additional Flux Required
- Low Melting Point (190° C. for 60/40 alloy)
- Approved by Air Ministry and G.P.O.
- All-British and acknowledged by the Leading Manufacturers to be the finest Cored Solder in the world.

### FREE

Two informative publications on soldering have been issued by Multicore Solders Ltd. Executives are invited to send for copies and a free sample of Multicore Solder.

**MULTICORE  
SOLDERS LTD.,**  
BUSH HOUSE,  
LONDON, W.C.2.  
Tel: TEMple Bar 5583/4



IT ALL SUMS UP TO  
ONE WORD

# Quality!

Nothing has been skimped in the manufacture of Erie high-grade resistance products. Only the finest raw materials that are so essential for efficient operation are used. Even in the face of rising production costs cheap substitutes that are "almost as good" do not find their way into Erie products.

That is why their performance has been steadily improved through the years. That is why today they give unparalleled all-round balanced performance. That is why you will find them used by those manufacturers who recognise the advantages of using only quality component parts.

CARBON RESISTORS  
TONE CONTROLS

WIREWOUND RESISTORS  
VOLUME CONTROLS  
SUPPRESSORS

## ERIE RESISTOR LIMITED

Carlisle Rd., The Hyde, Hendon, N.W.9.

Telephone: Colindale 8011

# A.V.C.

from grid or anode bend  
detectors

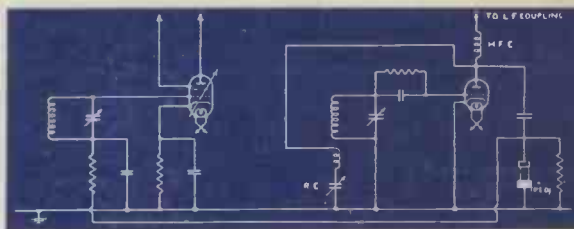

The circuit shows how the H.F. component in the anode circuit of a detector valve may be used, after rectification by means of a Westector, to provide the D.C. voltage for A.V.C., as well as for reaction. Full details of this, and other methods of obtaining A.V.C., are given in "The All Metal Way."

## Westinghouse

WESTINGHOUSE BRAKE & SIGNAL CO., LTD.,  
Pew Hill House, Chippenham, Wilts.

I enclose 3d. In stamps. Please send me "The All Metal Way."

NAME .....

ADDRESS .....

w.w.541

# marconi's make it

★ *If it is a matter of wireless apparatus for broadcasting or television; for naval or military purposes; for marine or air communications; for mobile or fixed aids to navigation; for any application whatever to practical requirements . . . ask Marconi's.*

*Because now, as in the earliest days of wireless experiment, Marconi's are pioneers in design and leaders in technical efficiency.*

For full particulars of all types of wireless apparatus, apply to Marconi's Wireless Telegraph Co., Ltd., Electra House, Temple Place, London, W.C.2.

Printed in England for the Publishers, ILIFFE AND SONS LTD., Dorset House, Stamford Street, London, S.E.1, by THE CORNWALL PRESS LTD., Paris Garden, Stamford Street, London, S.E.1. "The Wireless World" can be obtained abroad from the following: AUSTRALIA: Gordon & Gotch, Ltd., Melbourne (Victoria), Sydney (N.S.W.), Brisbane (Queensland), Adelaide (S.A.), Perth (W.A.), and Launceston (Tasmania). NEW ZEALAND: Gordon & Gotch Ltd. Wellington Auckland, Christchurch and Dunedin. INDIA: A. H. Wheeler & Co., Bombay, Allahabad and Calcutta. CANADA: Imperial News Co., Toronto, Winnipeg and Vancouver; Benjamin News Co., Montreal; Gordon & Gotch, Ltd., Toronto. SOUTH AFRICA: Central News Agency, Ltd.; Wm Dawson & Sons (S.A.), Ltd., Cape Town. UNITED STATES: The International News Co., New York

551